

SANITÄR

1 Standardkeramik



2 Komfortserien Keramik



3 Barrierefreie Keramik



4 Zweigriffmischbatterien



5 Einhebelmischer



6 Ventile



7 Thermostatbatterien



8 Brause - Zubehör



9 Küchenarmaturen / Einbauspülen / Ausgussbecken



10 Kleinteile und Zubehör für Armaturen



11 Accessoires



12 Badausattung



13 Badewannen und Duschwannen



14 Bodenebene Duschlösungen



15 Objektduschabtrennungen



16 Spülkästen AP und Zuehör



17 Vorwandmontage



18 Druckspüler



19 Schwimmerventile



20 Elektrospeicher



21 Durchlauferhitzer



22 Badeofen



23 WC Ablaufprogramm



24 Ablaufgarnituren für Waschtische



25 Ablaufgarnituren für Spülen



26 Gerätanschlüsse



27 Zubehör für Waschtisch, Spüle und Geräteanschlüsse



28 Ablaufgarnituren für Bidet



29 Ablaufgarnituren für Duschen



30 Ab-, Ein-, Überlaufgarnituren für Wannen



31 Ablaufgarnituren für Urinale



32 Kleinraumlüfter



Standardkeramik



Artikelnummer Bezeichnung



Abbildung

44100840	Waschtisch Gr.45 weiß	
44100940	Waschtisch Gr.50 weiß	
44101040	Waschtisch Gr.55 weiß	
44102040	Waschtisch Gr.60 weiß	
44103040	Waschtisch Gr.65 weiß	

44102041	Waschtisch Gr.60 weiß eckig Eurovit Plus	
44102042	Halbsäule für Waschtisch Gr.60 weiß eckig Eurovit Plus	

44150040	Stand-WC Flachspüler weiß	
44160040	Stand-WC Tiefspüler weiß	

<p>44167040 Wand-WC Flachspüler weiß</p>	
<p>44165040 Wand-WC Tiefspüler weiß</p>	
<p>44165041 Wand-WC Tiefspüler weiß Eurovit</p>	

<p>44180040 Urinal weiß Zulauf oben / Abgang universal mit verdeckter Befestigung</p>	
<p>44500640 Urinal weiß Zulauf verdeckt / Abgang univ. mit verdeckter Befestigung</p>	

22009002

D- Code Wand-Tiefspül-WC weiß
spülrandlos inkl. Absenksitz



31916100

Wand WC Spülrandlos mit verd.Befestigung
Tiefspüler weiß
inkl.WC Sitz m.Absenkaomatik





31915500

Wand WC Spülrandlos m.verd.Bef.eckig
Tiefspüler weiß
inkl.WC Sitz m.Absenkaomatik



43371502	Profiline WC Sitz Glasgow weiß mit Edelstahlbefestigung	
----------	--	--

43376030	SANIT WC Sitz 6000/weiß/Metallscharniere	
43376031	SANIT WC-Sitz 6000,beige	
43376033	SANIT WC Sitz 6000,pergamon	
43376034	SANIT WC Sitz 6000,manhattan	

43376086	WC Sitz Milano weiß mit Absenkautomatik und Clipp Off Funktion	
----------	---	--

Keramik Komfortserie

Artikelnummer Bezeichnung

Abbildung



29271350	IS Profiline Waschtisch 600mm rund	
29271410	IS Profiline Waschtisch 600mm Cube eckig	



29281740	IS Profiline Wand WC weiß Spülrandlos	
29271280	IS Profiline WC Sitz	
29271270	IS Profiline WC Sitz Softclosing	
29277240	IS Profiline WC Sitz Softclosing Flat	
29281743	IS Profiline Set Wand WC weiß Spülrandlos mit Sitz Softclosing	

29281744	IS Connect Urinal weiß ohne Deckel	
29281745	IS Connect Deckel Softclose für Urinal Connect weiß	



29229801	IS Connect Air Waschtisch 600mm Cube eckig	
29230901	IS Connect Air Halbsäule für Waschtisch Cube eckig	

29215501	IS Connect Air Wand WC weiß Spülrandlos	
29236807	IS Connect Air WC Sitz Softclosing	
29215511	IS Connect Air Set Wand WC weiß Spülrandlos mit Sitz Softclosing	

<p>29231630 IS Wand WC weiß Tonic II Spülrandlos</p>	
<p>29231580 IS Wand WC weiß Tonic II Aquablade</p>	
<p>29270640 IS WC Sitz Tonic II</p>	
<p>29270650 Ideal Standard WC Sitz Tonic II Softclose</p>	

<p>22009003 Durastyle Wand-Tiefspül-WC weiß spülrandlos inkl. Absenksitz, verdeckte Befestigung</p>	 
---	---

Keramik barrierefrei

<u>Artikelnummer</u>	<u>Bezeichnung</u>	<u>Abbildung</u>
51036101	Medikus Waschtisch Gr. 60 weiß mit Hahnloch, mit Überlauf	
51036109	Medikus Waschtisch Gr. 65 weiß mit Hahnloch, mit Überlauf	
51036110	Medikus Waschtisch Gr. 80 weiß Grip mit Hahnloch, mit Überlauf	
51004101	Medikus Stand-WC Tiefspüler weiß mit 6cm Sitzerrhöhung	
51003501	Medikus Stand-WC Flachspüler weiß mit 10cm Sitzerrhöhung	
51000701	Medikus Wand-WC Tiefspüler weiß 70cm	
51000101	Medikus WC Sitz weiß mit durchgehender Scharnierwelle	

Zweigriff Mischbatterien

Artikelnummer **Bezeichnung**



Abbildung

40322130	ZG DUSCHE 150 vc Abgang 1/2 o. Garnitur Griff 4201	
40322330	ZG Spüle/WT-Wand 150 vc Abgang 3/4 Griff 4201	
40330710	ZG SPÜ Einlochbatterie vc m.vers.Kette und HU-Auslauf 200 mm/Griff 4201	
40350840	ZG Niederdruck Spültischbatterie UT vc m. HU-Auslauf 200 mm/Griff 4201	
40335510	ZG WT Einlochbatterie vc m. vers. Kette und HU-Auslauf 130 mm/Griff 4201	
40350710	ZG Niederdruck UT WT Batterie vc m. HU-Auslauf 130 mm/Griff 4201	
50614118	SAM ZG MB ND f ÜT-Speicher WT vc RSA 200mm kompl.m.Bördelrohren	

Einhebelmischer

Artikelnummer Bezeichnung

Abbildung

34562750 EHM WT AquaFlow, verchromt inkl. Push&Open Ablaufgarnitur	
34562753 EHM WT AquaFlow, verchromt inkl. Push&Open Ablaufgarnitur, hohe Ausführung	

40347010 EHM WT Kuarto vc	 A modern, minimalist faucet with a tall, rectangular base and a long, horizontal spout extending to the right. The handle is integrated into the top of the base.
13104731 EHM WT Kuarto vc Cascade	 A faucet with a tall, rectangular base and a horizontal spout. The handle is positioned on the side of the base, and the spout has a slight downward curve.
13104921 EHM WT Kuarto vc mit hohem Auslauf und seitlichem Hebel	 A faucet with a tall, rectangular base and a high, curved spout. The handle is located on the side of the base, and the spout has a distinct downward curve.

29200704 EHM WT CeraPlan III 145/Version Grande mit Ablaufgarnitur



29200706 EHM WT CeraPlan III mit hohem Auslauf mit Ablaufgarnitur



29200716 EHM Dusche CeraPlan III



29200718 EHM Wafü CeraPlan III ohne Brausegarnitur



29206114

EHM Dusche CeraPlan III UP
Fertigbausatz



29206115

EHM Wafü CeraPlan III UP
Fertigbausatz



29210000

Unterputz Bausatz Easy Box
für EHM Wafü/ Dusche und Thermostate



<p>40330100 EHM WT Drako vc mit Ablaufgarnitur</p>	
<p>40330800 Einhebelmischer Dusche Drako vc ohne Brauseset</p>	
<p>40330500 EHM Wafü Drako Chrom mit Brauseset Drako</p>	

40068122	EHM WT Serie Xena vc mit Ablaufgarnitur	
40068165	EHM WT Serie XENA vc ND f. offene Heiß- wasserbereiter m. Ablaufgarnitur	
40066026	EHM WT Serie Verdana m.ausziehbarem Auslauf vc mit Ablaufgarnitur	
40068603	EHM Dusche Serie XENA vc ohne Brausegarnitur	
40068406	EHM Wafü Serie XENA vc o. Brausegarnitur	
40051485	EHM UP Uni-TecBox,Profiline Fun Kopenhagen Wafü u Dusche m. Abdruck- u.Spülvorrichtung	
40068695	EHM Dusche Xena für UP Tec-Box Fertigbauset, vc	
40068496	EHM Wafü Xena für UP Tec-Box Fertigbauset incl.Umsteller, vc	







40068123	EHM WT Serie Fun Napoli vc mit Ablaufgarnitur	
40068133	EHM WT Serie Fun Napoli vc ND für offene Heißwasserbereiter mit Ablaufgarnitur	
40068125	EHM Dusche Serie Fun Napoli vc ohne Brausegarnitur	
40068124	EHM Wafü Serie Fun Napoli vc ohne Brausegarnitur	

Ventile

Artikelnummer **Bezeichnung**

Abbildung

<p>47702600 Wandbrunnen aus Grauguß - grün 75 x 44 m.Nostalgie-Auslaufventil/Anschl.rücks. 1/2</p> 	
<p>40307000 Wand-Schwenkventil m.S-Auslauf vc 200mm Griff 4201</p>	
<p>40311010 Standventil 1/2 vc Griff 4201</p>	
<p>40333510 Stand-Schwenkventil vc m. HU-Auslauf 130mm Griff 4201</p>	
<p>40311000 Befestigungsset zu Standventilen 1/2" 3tlg</p>	

50843999	Steckschlüssel 6mm m.Innenvierkant für Auslaufventile ohne Knebel	
50844000	Auslaufventil mit Steckschlüssel-Oberteil 1/2" m.vc	
50844003	Auslaufventil 1/2 m.Knebel matt vc ProfiLine	
50844004	Auslaufventil 1/2 m.Knebel pol.vc ProfiLine	
50844005	Auslaufventil 3/4 m.Knebel pol.vc ProfiLine	
50844006	Auslaufventil 3/4 m.Knebel matt vc ProfiLine	
50844007	Auslaufventil 1/2 m.RB matt vc	
50844008	Auslaufventil 1/2 m.RB pol vc	
50844100	Schlauchverschraubung f.Auslaufventil 1/2"	
50844200	Schlauchverschraubung f.Auslaufventil 3/4"	
50845012	Oberteil für Auslaufventil 1/2 m.Knebel pol.vc	
50845034	Oberteil für Auslaufventil 3/4 m.Knebel pol.vc	

50951721	Geräteventil f.Eckventil 3/8"x10x3/4" Schl pol. vc m.Rückflussverhinderer ProfiLine	
50951788	Auslauf-Doppelventil m. RB vc	
50951789	Auslauf-Doppelventil m. RB und 1/2 IG vc	

50952810	Frostsichere Außenarmatur 1/2 vc m. RV + RB von 240 - 410mm	
50952811	Frostsichere Außenarmatur 1/2 vc m. RV + RB von 380 - 620mm	
28051500	Verlängerungsset für frostsichere Außenarmatur Frost Tec 18cm	



50953250	Auslauf - Kugelhahn 1/2	
50953260	Auslauf - Kugelhahn 3/4"	
50953240	Auslauf - Kugelhahn 1"	

50953270	Auslaufventil 1/2" Dreikant Haubengriff mit Luftsprudler vc	
50953280	Auslaufventil 1/2 Dreikant Haubengriff lange Ausf. vc	
50953290	Auslaufventil 1/2 kurze Ausführung vc ProfiLine für Waschmaschine	

50451634	Schlauchplatzsicherung 3/4" vc für Geräteanschlußarmaturen	
----------	--	---

58202020	Rohrbelüfter 3/4" IG+AG vc passend zu Ventil 1/2"	
----------	---	---

50954098	Gabelstück 1/2" AG/IG/IG vc	
50954034	Gabelstück 3/4" IG/AG/AG vc	

40410600	Oberteil m.Acrylgriff kompl. Warm 3/8 vc	
40410615	Oberteil m.Acrylgriff kompl. Warm 1/2 vc	
40410601	Oberteil m.Acrylgriff kompl. Kalt 3/8 vc	
40410616	Oberteil m.Acrylgriff kompl. Kalt 1/2 vc	
50825301	Oberteil m.Dreisterngriff 3/8 rot M 30	
50825302	Oberteil m.Dreisterngriff 3/8 bl M 30	
50825311	Oberteil m.Dreisterngriff 1/2 rot M 31	
50825312	Oberteil m.Dreisterngriff 1/2 bl M 31	
50825321	Oberteil m.Dreisterngriff 3/4 rot	
50825322	Oberteil m.Dreisterngriff 3/4 bl	

40400018	Ventiloberteil 1/2 keramisch dichtend 90° 1/4 Umdrehung / rechtsschließend	
40409251	Ventiloberteil 1/2 keramisch dichtend 90° 1/4 Umdrehung / linksschließend	



40425000	Ventiloberteil 3/8	
40425015	Ventiloberteil 1/2	
40425020	Ventiloberteil 3/4	

40425200	Rastbuchse zu Armaturen-Oberteilen	
----------	------------------------------------	---

Thermostat Mischbatterien

Artikelnummer Bezeichnung

Abbildung

40333400	Thermostat Batterie Dusche Drako vc ohne Brauseset	 A sleek, modern chrome shower mixer tap with a single-lever handle and a curved spout. It is shown from a three-quarter perspective, highlighting its cylindrical design and polished finish.
40671130	Thermostat-Batterie Dusche o.Garnitur vc	 A chrome shower mixer tap with a single-lever handle and a curved spout. It is shown from a three-quarter perspective, highlighting its cylindrical design and polished finish. The brand name 'RUBINOR' is visible on the handle.

40634406	Thermostat Batterie Wafü Fun Napoli vc mit Umsteller Serie Profiline	 A chrome shower mixer tap with a single-lever handle and a curved spout. It is shown from a three-quarter perspective, highlighting its cylindrical design and polished finish. The brand name 'RUBINOR' is visible on the handle.
----------	--	---

38857978

Duschsystem mit Teleskopstange
Thermostatbatterie mit
Kopf und Handbrause vc



38857980

Duschsystem mit Thermostatbatterie
inklusive Ablage
mit Kopf u.Handbrause vc





Brausegarnituren

Artikelnummer **Bezeichnung**

Abbildung

57593406	Profiline Brause Wandstange Fun 600mm mit Halter	
57593409	Profiline Brause Wandstange Fun 900mm mit Halter	
35905720	Brause Wandstange Metall 900mm mit Gleiter aus Messing	

40602850	Brauseschlauch für UP EHM Wannenrand M15 AG x 1/2 ÜM konisch, d= 12,5mm , 2m	
----------	---	---

50824501	Brauseschlauch Metall vc 1,75 m verdrehssicher	
50824503	Brauseschlauch Metall vc 1,50 m verdrehssicher	

57593420	Profiline Brauseschlauch Fun 125mm mit Drehkonus	
57593421	Profiline Brauseschlauch Fun 160mm mit Drehkonus	
57593422	Profiline Brauseschlauch Fun 200mm mit Drehkonus	

58073075	Brauseschlauch Kst ummantelt 0,75 m	
58073125	Brauseschlauch Kst ummantelt 1,25 m	
58073150	Brauseschlauch Kst ummantelt 1,50 m	
58073200	Brauseschlauch Kst.ummantelt, 2,0 m	

57593410 Handbrause Profiline LIGHT VC Einstrahlig



57593411 Handbrause Profiline FUN VC 3-fach verstell



57591614 Handbrause Bravat weiß / verchromt
Switsch Funktion - 3 fach



29021760 Handbrause Evo Jet Diamond
chrom 134 mm



29021759

Handbrause Evo Jet rund
chrom 125 mm



40471300





Handbrause Kuartro vc stabförmig eckig
Metall

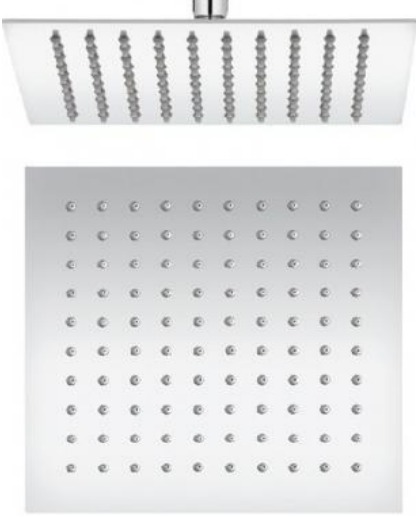

57573713

Handbrause Odisea vc stabförmig





<p>57576559 Kopfbrause vc 250 mm rund</p>	
<p>57576558 Kopfbrause vc 300 mm eckig</p>	
<p>57576556 Kopfbrause Diamond 400x250mm 1/2" mit Kugelgelenk</p>	
<p>57576608 Brausearm 350/300 mm vc 1/2" rund ohne Brausekopf</p>	
<p>57576607 Brausearm 400 mm vc 1/2" eckig BK350 ohne Brausekopf</p>	
<p>57576606 Brause - Deckenanschluss 150mm 1/2" ohne Brausekopf</p>	

21392200

Brausegarnitur Orta 4 Renov.system m.Hand-
u.Regenbrause zum Anschluss an Brausearmatur



58197000	Wandanschlußbogen 90° vc 1/2" x 1/2"	
12211476	Wandanschlußbogen 90° vc 1/2" x 1/2" eckig	
50824747	Brause Wandanschlussbogen Arran vc mit Brausehalter	
50824749	Brause Wandanschlussbogen KUATRO vc mit Brausehalter	

50824571	Brause Wandhalter vc	
50824748	Brause Wandhalter KUATRO vc	

Küchenarmaturen / Einbauspülen /
Ausgussbecken

Artikelnummer Bezeichnung

Abbildung

13517244	EHM Spüle Oslo mit Schwenkauslauf weiß	 The image shows two kitchen faucets. The top one is white and has a modern, minimalist design with a single-lever handle and a curved spout. The bottom one is chrome and has a more traditional design with a single-lever handle and a curved spout.
13517872	EHM Spüle Oslo mit Schwenkauslauf und hohem Rohrauslauf, chrom	

13558248	EHM Spüle Sydney mit Schwenkauslauf Höhe Auslauf 16,5cm, Stahl	 The image shows two chrome kitchen faucets. The top one has a curved spout and a single-lever handle. The bottom one has a curved spout and a single-lever handle, and it appears to have a pull-out spray head.
13558272	EHM Spüle Sydney mit Schwenkauslauf und herausziehbarer Brause, chrom	

13562251	EHM Spüle Nizza mit Schwenkauslauf chrom	
----------	---	---



40068126	EHM Spüle Serie Fun Napoli vc Schwenkauslauf, Wandmontage	
40068127	EHM Spüle Serie Fun Napoli vc Schwenkauslauf	
40068128	EHM Spüle Serie Fun Napoli vc ND Schwenkauslauf	
40068129	EHM Spüle Serie Fun Napoli vc Schwenkauslauf, mit Geschirrbrause	
40068130	EHM Spüle Serie Fun Napoli vc mit schwenkbarem hohem Rohrauslauf	

35735142	EHM Spüle Serie Palma vc	
35735162	EHM Spüle Serie Palma vc ND für Niederdruck-Heißwasserspeicher	

40068802	EHM Spüle Serie XENA /Profiline Ibiza mit schwenkbarem Auslauf	
40068803	EHM Spüle Serie XENA/Profiline Ibiza m. ausziehbarer Handbrause	
40068801	EHM Spüle Serie XENA/Profiline Ibiza Wandarmatur mit 200mm Auslauf	



40330610	EHM Spüle Drako mit schwenkbarem hohem Rohrauslauf 185 mm vc	
----------	---	---

40362802	EHM Spüle Lisboa mit schwenkbarem hohem Rohrauslauf vc	
----------	--	---

40590000	Küchenbrause 1/2 vc für EHM Spüle mit herausz. Brause	
40600000	Brauseschlauch f.EHM m.herausz.Brause 1,5m Konus M15x1,0 AG x 1/2" IG,Schlauch d=15mm	

51013000	Einbauspüle 860x435 mm Edelstahl mit Ablaufgarnitur,ohne Bohrung/reversibel	
51510503	Auflagespüle 1000 x 600 mm Edelstahl ohne Bohrung,reversibel, ohne Ablaufgarn.	

47700201	Wandausgußbecken mit Rückwand ,Kst. weiß	
47700203	Wandausgußbecken mit Rückwand ,Kst. granit	

<p>47700300 Wandausgußbecken mit Rückwand, Edelstahl</p>	
<p>47700200 Wandausgußbecken mit Rückwand, Stahlblech emailliert, weiß</p>	
<p>47700202 Klapprost für Wandausgußbecken mit Rückwand, Stahlblech emailliert, weiß</p>	

47707121	abu multiset Funktionsbecken Farbe granit m.Seifenschale u.Handtuchhalten	
47707130	Ablageset für abu multiset Funktionsbecken Abtropfschale und Auflagerost anthrazit	
47707150	abu maxi Becken mit Überlauf 33Ltr. weiß	
47700698	Klapprost für Wandausgußbecken, grau passend zu Kunststoff-Ausgussbecken	

Kleinteile und Zubehör Armaturen

Artikelnummer Bezeichnung

Abbildung

40433010	Luftsprudler M 24 x 1 AG vc	
40433020	Luftsprudler M 24 x 1 AG vc Comfort DIN 52218	
40434010	Luftsprudler M 28 x 1 AG vc	
40431002	Luftsprudler M 24 x 1 AG / ND vc	
40431001	Luftsprudler M 22 x 1 IG / ND vc	
40432000	Luftsprudler M 22 x 1 IG vc	
40432200	Luftsprudler Verlängerungsschlauch M22x1 IG vc	
40432300	Luftsprudler m. Kugelgelenk M 22x1 IG vc	
40432700	Luftsprudler-Einsatz für M 22x1 und M24x1 vc	
40432800	Luftsprudler - Einsatz M 28 x 1 vc	
40436569	Luftsprudler - Schlüssel	

50844103	Eckventil 1/2 vc. inkl Probenahme Entnahmerohr aus Edelstahl	
50844021	Eckventil 3/8 ohne Dichtung vc	
50844001	Eckventil 1/2 ohne Dichtung vc	
50844002	Eckventil 1/2 mit Dichtung vc ProfiLine	
50575561	Thermostat zur Montage auf Eckventil 2 x 3/8" AG mischt Kalt-und Warmwasser	
58273000	Kombi Eckventil 1/2 vc ProfiLine	
58273010	Kombi-Eckventil 1/2 mit Rohrbelüfter vc ProfiLine	

50829000	SAF Rosette 1/2" f.45-er Arm.		
40433231	Rosette 3/4" x 30mm / Außen Ø 65mm vc		
40433230	Rosette 3/4" x 30mm / Außen Ø 80mm		
40433105	Rosette 1/2" x 5mm vc		
40433110	Rosette 1/2" x 10mm vc		
40433115	Rosette 1/2" x 15mm vc		
40433125	Rosette 1/2" x 25mm vc		
40433130	Rosette 1/2" x 30mm vc		
40433135	Rosette 1/2" x 35mm vc		
40433142	Rosette 1/2" x 42mm vc		
40433205	Rosette 3/4" x 5mm vc		
40433210	Rosette 3/4" x 10mm vc		
40433220	Rosette 3/4" x 20mm vc		
40433225	Rosette 3/4" x 25mm vc		
40433250	Rosette 3/4" x 50mm vc		
404106110	Blindrosette MS vc Breite:61mm Höhe:10mm		





<p>40321431 Standanschluß vc</p>	
---------------------------------------	---

<p>40434000 S-Anschluß AG 1/2 x IG 3/4</p>	 
<p>40433100 Gewinde-Rosette für "S" Anschluß 30x70x27 vc</p>	
<p>40430000 Gewinde-Rosette mit "S"-Anschluß 1/2x3/4</p>	
<p>22151414 S-Anschluss 40mm versetzt 1/2" AG auf 3/4 AG</p>	





80405500 Verteilerstück, MS vc ÜM IG 3/4" auf 2x AG 3/4"	
---	---

50954108 VC Doppelverschraubung winklig 8 mm	
50954110 VC Doppelverschraubung winklig 10 mm	
50954112 VC Doppelverschraubung winklig 12 mm	
50954115 VC Doppelverschraubung winklig AG/Quetsch 3/8 x 10 mm	

50954130 VC Verschraubung T-Form 8 mm	
50954122 VC Verschraubung T-Form 12 mm	
50954120 VC Verschraubung T-Form 10 mm	
50954119 VC T-Stück 1/2" IG AG x 10 mm Que	
50954118 VC Verschraub T-Form 2 x10 mm ÜM 1x 10mm	
50954117 VC Verschraubung T-Form 3/8" IG 2 x 10 mm	

50954139	VC Doppelverschraubung gerade 8 x 8 mm Gewinde am Überwurf 3/8"	
50954140	VC Doppelverschraubung gerade 10x10 mm Gewinde am Überwurf 3/8"	
50954141	VC Doppelverschraubung gerade 12x12 mm Gewinde am Überwurf 1/2"	

50954152	VC Quet.-Überwurfmutter 3/8 x 10 mm konisch	
50954154	VC Quet.-Überwurfmutter 1/2 x 10 mm konisch	
50954155	VC Quet.-Überwurfmutter 1/2 x 12 mm konisch	
50954162	VC Quet.-Überwurfmutter 3/8 x 10 mm vc mit Längenausgleich	

50954131	VC Verschraubung gerade 1/2 AG x 10 mm	
50954160	VC Verschraubung gerade 3/8IG x 10 mm Quet	



58387040	CU Rohr vc 8mm / VPE 5m	
58387050	CU Rohr vc 10mm / VPE 5m	







40430400	Schwenkbarer "S" Auslauf 150 mm vc 3/4" IG	
40430500	Schwenkbarer "S" Auslauf 200 mm vc 3/4" IG	
40430600	Schwenkbarer "S" Auslauf 250 mm vc 3/4"IG	
40430700	Schwenkbarer "S" Auslauf 300 mm vc 3/4"	
40430800	Schwenkbarer "U" Auslauf ausziehbar 3/4"IG 200-300 mm vc	
40430900	Schwenkbarer "U" Auslauf ausziehbar 3/4"IG 280-480 mm vc	
40431000	Schwenkbarer "U" Auslauf ausziehbar 3/4"IG 350-600 mm vc - drucklos -	
40431100	Schwenkbarer "U" Auslauf 200 mm vc 3/4"IG	
40431200	Schwenkbarer "U" Auslauf 300 mm vc 3/4"IG	
40431300	Schwenkbarer "HU" Auslauf 130 mm vc 3/4"IG	
40431400	Schwenkbarer "HU" Auslauf 155 mm vc 3/4"IG	
40431500	Schwenkbarer "HU" Auslauf 200 mm vc 3/4"IG	
40431600	Schwenkbarer "HU" Auslauf 250 mm vc 3/4"IG	
40802920	Schwenkbarer "S" Auslauf 200 mm vc 1/2" ÜM für ND Armatur	
40802925	Schwenkbarer "S" Auslauf 250 mm vc 1/2" ÜM für ND Armatur	
40802930	Schwenkbarer "S" Auslauf 300 mm vc 1/2" ÜM für ND Armatur	
40431700	Schwenkbarer Gußauslauf zu Spültisch-Batterie 200 mm vc 3/4"IG	
40431701	Schwenkbarer Auslauf schwere Bauform zu Spültisch-Batterie 300 mm vc 3/4"IG	

Accessoires

Artikelnummer Bezeichnung

Abbildung

00633210	Profiline Doppelhaken vc zum ankleben o.anschauben	
00636210	Profiline Doppelhaken vc eckig zum ankleben o.anschauben	
00778010	Profiline Einzelhaken vc zum ankleben o.anschauben	
00129941	Power Kleber zur Befestigung der Accessoires	
70211132	Profiline Handtuchhalter vc zweiarmig	

70210005	Profiline Papierhalter mit Deckel vc	
70210234	Profiline Papierhalter vc	
62925201	Papierhalter ohne Deckel New York	
70210616	Profiline Toilettenbürstengarnitur vc	
70210617	Profiline Ersatzglas für Toilettenbürstengarnitur vc	
70106773	Profiline Ersatzbürstenkopf für Toilettenbürstengarnitur	
70210618	Profiline Ersatzbürste für Toilettenbürstengarnitur vc	

<p>64003034 SAM Duschway Eckschwammkorb vc</p>	
<p>64003035 SAM Duschway Schwammkorb vc gebogen</p>	
<p>64003036 SAM Duschway Schwammkorb vc gerade</p>	

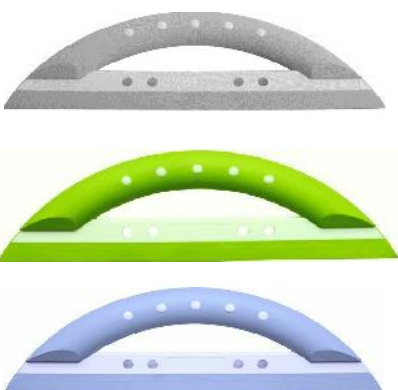
<p>11022206 Duschabzieher Kunststoff ohne Halter Hellgrau/ Limette/ Aquamarin</p>	
---	---

38000002	Ravak Duschsitz OVO-P ovale Form klappbar Sitzfläche aus Kunststoff orange	
38000004	Ravak Duschsitz OVO-P ovale Form klappbar Sitzfläche aus Kunststoff Milchglas	
38000006	Ravak Duschsitz OVO-B eckige Form klappbar Sitzfläche aus Kunststoff Milchglas	
10854002	abu lifestyle Sitz für Dusche,Bad& Wellness Absenkautomatik, höhenverstellbar	

70211264	Profiline Wannengriff 300mm vc	
----------	--------------------------------	---

Badmöbel - Badausstattung











vorher



nachher





Badewannen & Duschwannen

Artikelnummer Bezeichnung



Abbildung

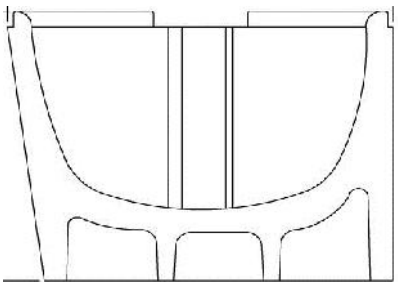

31076070	Badewanne 160 x 70 weiß emailliert	
31077075	Badewanne 170 x 75 weiß emailliert	

34126070	Acryl Badewanne 160 X 70 Standard weiß Dola	
34127075	Acryl Badewanne 170 X 75 Standard weiß	



34100030	Acryl Badewannen Fußgestell: 2 Traversen mit 4 verstellbaren Füßen 11 - 19 cm	
34100039	Acryl Badewannen Fußgestell mit 3 schallge- dämmten Klemmleisten, 2 Klemmbügel	

44029405	Wannenträger,170x75,Vario, Einbau universal eine gerade, eine schräge Seite	
44029425	Wannenträger,160x70,Vario, Einbau universal eine gerade, eine schräge Seite	
44029426	Wannenträger 160x70 Einbau universal eine gerade, eine schräge Seite für Dola	

34708860	Acryl Duschwanne 80 x 80 x 6,5 cm weiß	
34709720	Acryl Duschwanne 90 x 75 x 2,5 cm weiß TSB 112	
34709860	Acryl Duschwanne 90 x 80 x 6,5 cm weiß	
34709920	Acryl Duschwanne 90 x 90 x 2,5 cm weiß	
34701120	Acryl Duschwanne 100 x 100 x 2,5 cm weiß	
34701886	Träger für Acryl Duschwanne 80 x 80 x 6,5cm TSB 16 Trägerhöhe 19 cm	
34701972	Träger für Acryl Duschwanne 90 x 75 x 2,5cm TSB 112 Trägerhöhe 14 cm	
34701986	Träger für Acryl Duschwanne 90 x 80 x 6,5cm TSB 13 Trägerhöhe 19 cm	
34701992	Träger für Acryl Duschwanne 90 x 90 x 2,5cm TSB 9 Trägerhöhe 14 cm	
34701112	Träger für Acryl Duschwanne 100x100x2,5 cm TSB 8 Trägerhöhe 13,5cm	

34728860	Acryl Viertelkreis Duschwanne 80x80x6,5 cm weiß Radius 500	
34729920	Acryl Viertelkreis Duschwanne 90x90x2,5 cm weiß Radius 550	
34729960	Acryl Viertelkreis Duschwanne 90x90x6,5 cm weiß Radius 500	
34721160	Acryl Viertelkreis Duschwanne 100x100x2,5cm weiß Radius 550	
34730886	Träger für Acryl Viertelkreis Duschwanne 80 x 80 x 6,5 cm R 500 TSB 20 Trägerh.19cm	
34730992	Träger für Acryl Viertelkreis Duschwanne 90 x 90 x 2,5 cm R 550 TSB 28 Trägerh.14cm	
34730996	Träger für Acryl Viertelkreis Duschwanne 90 x 90 x 6,5 cm R 500 TSB 23 Trägerh.19cm	
34730116	Träger für Acryl Viertelkreis Duschwanne 100x100x2,5 cm R 550 TSB 29 Trägerh.14cm	

33480800	Acryl Duschwanne 80 x 80 x 4,5 2,5cm innen, weiß	
33490900	Acryl Duschwanne 90 x 90 x 4,5 2,5cm innen, weiß	
33410080	Acryl Duschwanne 100 x 80 x 4,5 2,5cm innen, weiß	
33412090	Acryl Duschwanne 120 x 90 x 4,5 2,5cm innen, weiß	
33414090	Acryl Duschwanne 140 x 90 x 4,5 2,5cm innen, weiß	
23907524	Träger für Acryl Duschwanne RIHO 80x80x4,5 Trägerhöhe 14cm	
23907502	Träger für Acryl Duschwanne RIHO 90x90x4,5 Trägerhöhe 14cm	
23907532	Träger für Acryl Duschwanne RIHO 100x80x4,5 Trägerhöhe 14cm	
23907503	Träger für Acryl Duschwanne RIHO 120x90x4,5 Trägerhöhe 14cm	
23907504	Träger für Acryl Duschwanne RIHO 140x90x4,5 Trägerhöhe 14cm	

31060040	Brausewanne flach 80x80 weiß, emailliert	
31063040	Brausewanne flach 90x75 weiß, emailliert	
31061040	Brausewanne flach 90x90 weiß, emailliert	
35550088	Brausewannenträger 80x80 flach	
35550079	Brausewannenträger 75x90 flach	
35550099	Brausewannenträger 90x90 flach	

33422005

Mineralgussduschwanne 900x900x30
Premium, weiß seidenmatt, Velvet Soul



29282150





Mineralgussduschwanne 900x900x30
weiß Natursteinstruktur, Ultra Flat S





29282160

Mineralgussduschwanne 1000x1000x30
weiß Natursteinstruktur, Ultra Flat S



33414005	Mineralgussduschwanne 900 x 900 x 30,weiß Viertelkreis,inkl. Siphon und Füße,KOLPING	
33414115	Schürze für Mineralgussduschwanne Viertelkreis, 900 x 900 / Höhe 65,KOLPING	
33421005	Mineralgussduschwanne 900 x 900 x 30 weiß, inkl. Siphon und Füße, KOLPING	
33421015	Schürze für Mineralgussduschwanne 900 x 900 / Höhe 65, KOLPING	
33431005	Mineralgussduschwanne 1000 x 800 x 30 weiß, inkl. Siphon und Füße, KOLPING	
3343132005	Mineralgussduschwanne 1000 x 900 x 30	
33433005	Mineralgussduschwanne 1200 x 800 x 30 weiß, inkl. Siphon und Füße, KOLPING	
33434005	Mineralgussduschwanne 1200 x 900 x 30 weiß, inkl. Siphon und Füße, KOLPING	
33436005	Mineralgussduschwanne 1400 x 900 x 30 weiß, inkl. Siphon und Füße, KOLPING	

<p>34730999 Acryl Duschwannenfußgestell Einbauhöhe 90 bis 120 mm</p>	
<p>31100100 Universal Brausewannenfußgestell DP5 Einbauhöhe 125 bis 185 mm</p>	

<p>31102004 Wannenrandanker 3er Set Wannenrand- klemmstücke</p>	
<p>31102005 Wannenrandanker 2er Set Wannenrand- klemmstücke</p>	
<p>31102020 Wannenrand Klemmleisten Set 2 St.Profilleisten + 2 St. Wannenrandanker</p>	



34180040 Wannenabdichtband für Acryl-, Stahl- und
Marmorguss- Dusch und Badewannen 3,80m



34180044 Wannenabdichtband für Acryl-, Stahl- und
Marmorguss- Dusch und Badewannen 10m





Bodenebene Duschlösungen

Artikelnummer **Bezeichnung**

Abbildung

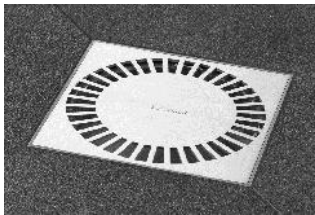





17244000	M2 Siphongehäuse Abgang nach unten passend an ESS Duschrinnen	
17244070	Duschrinne komplett zum Verfliesen L 700 x B 72mm BH 93mm	
17244080	Duschrinne komplett zum Verfliesen L 800 x B 72mm BH 93mm	
17244090	Duschrinne komplett zum Verfliesen L 900 x B 72mm BH 93mm	
17244100	Duschrinne komplett zum Verfliesen L 1000 x B 72mm BH 93mm	
17244071	Duschrinne komplett mit Edelstahlabdeckung L 700 x B 72mm BH 93mm	
17244081	Duschrinne komplett mit Edelstahlabdeckung L 800 x B 72mm BH 93mm	
17244091	Duschrinne komplett mit Edelstahlabdeckung L 900 x B 72mm BH 93mm	
17244101	Duschrinne komplett mit Edelstahlabdeckung L 1000 x B 72mm BH 93mm	

17244150	Duschablauf Komplettsset,inkl Edelstahl- Abdeckung, 15x15cm,senkrecht u.waagrecht 	
----------	---	---

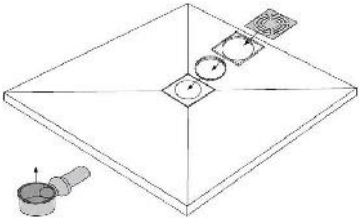

17107687	Duschrinne ACO Rohbauset umlfd. Flansch L 700 inkl. Ablauf und FüÙe Profiline
17107688	Duschrinne ACO Rohbauset umlfd. Flansch L 800 inkl. Ablauf und FüÙe Profiline
17107689	Duschrinne ACO Rohbauset umlfd. Flansch L 900 inkl. Ablauf und FüÙe Profiline
17107690	Duschrinne ACO Rohbauset umlfd. Flansch L 1000 inkl. Ablauf und FüÙe Profiline
17107228	Abdeckung für Duschrinne ACO L 700 Profiline zum Verfliesen
17107229	Abdeckung für Duschrinne ACO L 800 Profiline zum Verfliesen
17107230	Abdeckung für Duschrinne ACO L 900 Profiline zum Verfliesen
17107231	Abdeckung für Duschrinne ACO L 1000 Profiline zum Verfliesen
17107232	Abdeckung für Duschrinne ACO Edelstahl L 700 Profiline
17107233	Abdeckung für Duschrinne ACO Edelstahl L 800 Profiline
17107234	Abdeckung für Duschrinne ACO Edelstahl L 900 Profiline
17107235	Abdeckung für Duschrinne ACO Edelstahl L 1000 Profiline



351000601	LDG bodenebenes Duschelement 90 x 90 Ablauf zentriert senkrecht	
351000604	LDG bodenebenes Duschelement 100 x 100 Ablauf zentriert senkrecht	
351000608	LDG bodenebenes Duschelement 120 x 120 Ablauf zentriert senkrecht	
351000621	LDG bodenebenes Duschelement 90 x 90 Ablauf zentriert waagrecht	
351000624	LDG bodenebenes Duschelement 100 x 100 Ablauf zentriert waagrecht	
351000628	LDG bodenebenes Duschelement 120 x 120 Ablauf zentriert waagrecht	
351000640	LDG bodenebenes Duschelement 90 x 90 Viertelkreis R500 - Ablauf zentriert senkr.	
351000641	LDG bodenebenes Duschelement 100 x 100 Viertelkreis R500 - Ablauf zentriert senkr.	
351000642	LDG bodenebenes Duschelement 90 x 90 Viertelkreis R500 - Ablauf zentriert waager.	
351000643	LDG bodenebenes Duschelement 100 x 100 Viertelkreis R500 - Ablauf zentriert waager	
351000686	Aufsatzrahmen für LDG bodenebenes Duschelement	
351000701	Ablauf für LDG bodenebenes Duschelement waagrecht	
351000702	Ablauf für LDG bodenebenes Duschelement senkrecht	

Objekt-Duschabtrennungen

Artikelnummer Bezeichnung

Abbildung

38321111	Verbreiterungsprofil für Duschtüren und Seitenwände 20mm x 1880 weiß / ANPS	
38320111	Verbreiterungsprofil für Duschtüren und Seitenwände 20mm x 1850 weiß / NPS	

38312030	EckEinstiegshälfte 100x188 3-teilig Kunstglas / Profil weiß	
38311930	EckEinstiegshälfte 90x188 3-teilig Kunstglas / Profil weiß	
38311830	EckEinstiegshälfte 80x188 3-teilig Kunstglas / Profil weiß	
38311730	EckEinstiegshälfte 75x188 3-teilig Kunstglas / Profil weiß	

<p>38300920 Eckeinstiegshälfte 90x185 2-teilig Kunstglas / Profil weiß</p>	
<p>38300820 Eckeinstiegshälfte 80x185 2-teilig Kunstglas / Profil weiß</p>	
<p>38300720 Eckeinstiegshälfte 75x185 2-teilig Kunstglas / Profil weiß</p>	

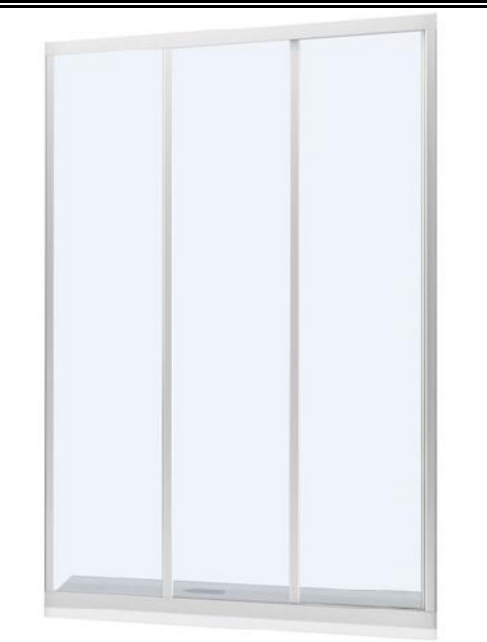
<p>38310200 Duschgleittür 1000 x 1880 3-tlg. Kunstglas /Profil weiß ASDP 3-100</p>	
<p>38310190 Duschgleittür 900 x 1880 3-tlg. Kunstglas /Profil weiß ASDP 3-90</p>	
<p>38310180 Duschgleittür 800 x 1880 3-tlg. Kunstglas /Profil weiß ASDP 3-80</p>	

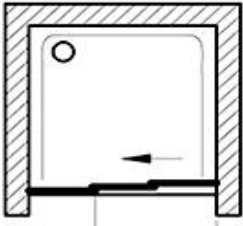
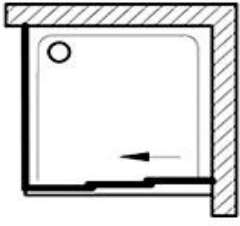
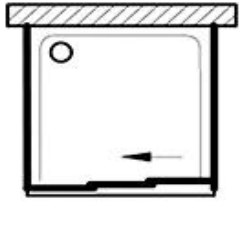
	ASDP3	ASDP3 + APSS	ASDP3 + APSS + APSS
			
38230190	Seitenteil 900 x 1880 Kunstgl./Profil weiß passend zu Eckeinstieg 3tlg und Schiebetür		
38230180	Seitenteil 800 x 1880 Kunstgl./Profil weiß passend zu Eckeinstieg 3tlg u.Schiebetür		
38230175	Seitenteil 750 x 1880 Kunstgl./Profil weiß passend zu Eckeinstieg 3tlg u.Schiebetür		
38230140	Seitenteil 400 x 1880 Kunstgl./Profil weiß Sondermaß für Schachtbefestigung		
38230090	Seitenteil 900 x 1850 Kunstgl./Profil weiß		
38230080	Seitenteil 800 x 1850 Kunstgl./Profil weiß		
38230075	Seitenteil 750 x 1850 Kunstgl./Profil weiß		



38100804

Rund-Duschabtrennung SKCP 4-teilig
90x90x185 Kunstglas /Profil weiß R500



38100800

Rund-Duschabtrennung SKKP 6-teilig
80x80x185 Kunstglas /Profil weiß R500



Spülkästen AP und Zubehör

Artikelnummer **Bezeichnung**

Abbildung

46210120 SANIT Spülkasten 937 tiefhängend weiß



46210130 SANIT Spülkasten 928 6-9 l tiefh. Weiß



46210135 SANIT Spülkasten 951 6-9l tiefh. weiß mit 2-Mengenspülung















47601501 Spülkasten AP 6l weiß tiefhängend





47602301 Spülkasten Eck 6-9 l weiß



46210129	SANIT Spülkasten junior tiefhängend beige	
46210124	SANIT Spülkasten tiefhängend,manh.	
46210123	SANIT Spülkasten tiefhängend pergamon	

46701000	SANIT Spülrohrbogen 45° DN 40, weiß	
46704001	SANIT Spülrohrbogen 90°DN40 230x230 weiß	
46706391	SANIT Spülrohrbogen 90°DN40 350x150, weiß	
46703000	SANIT Spülrohrbogen 90°DN40 380x210,weiß	
46706401	SANIT Spülrohrbogen 90°DN40 390x350, weiß	
46703101	SANIT Spülrohrb.versetzt links, 40mm,weiß	
46703201	SANIT Spülrohrb.versetzt rechts, 40mm weiß	
46706300	SANIT Sichelbogen DN 40 135° m.Kleber weiß	
46706102	Spülrohrverlängerung DN 50 x 250 weiß mit Lippendichtung	
46705001	SANIT Spülrohrverlängerung DN40 x 300,weiß	
46706001	SANIT Spülrohrverlängerung DN40 x 500,weiß	

<p>46210201 SANIT Spülkasten junior hochh. weiß 6 Ltr.</p>	
<p>46725001 SANIT Spülrohr u.Bogen 90° DN 32,weiß für hochhängenden Spülkasten junior</p>	
<p>46706100 SANIT Spülrohrbogen 45° DN 32 weiß</p>	
<p>46725010 SANIT Spülrohrbogen 90°DN32,weiß</p>	

<p>46023310 Sanit Dichtring 110 x 70 x 15 f.Armaturenset-aufs.Spülkasten 942</p>	
<p>46600001 SANIT Armaturenset für aufsitzende Ke- ramiksp. mit Deckelloch 18 u. 38mm</p>	









Vorwandmontage

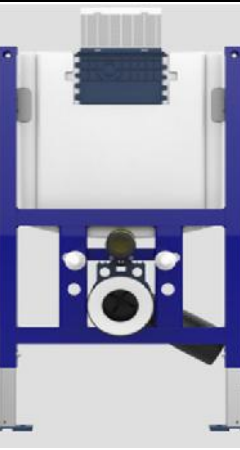
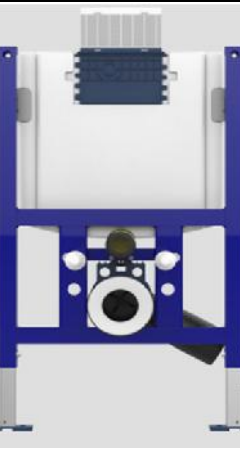

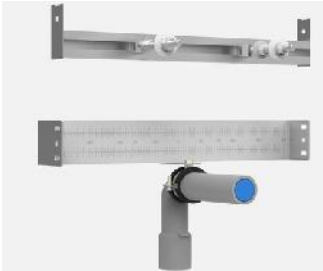

Artikelnummer **Bezeichnung**

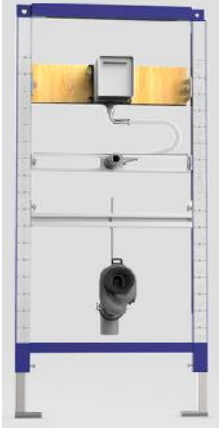

Abbildung

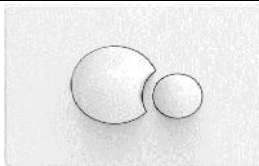
SANIT

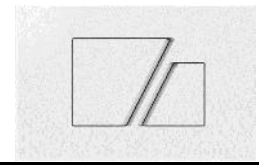
30906733	SANIT WC-Element INEOPlus BH1120mm 450mm breit, Bet.vorn ohne Wandhalter	 A blue metal frame for a wall-mounted toilet element. It features a white rectangular panel at the top with two small square openings. The frame is designed to be mounted on a wall.
30906080	SANIT WC-Element INEO80 1185/665/95 Bet.von vorn, 80 tief, kleine Rev.öff. o.Wandhalter	 A blue metal frame for a wall-mounted toilet element. It has a white panel with a central circular opening for the toilet bowl. The frame is designed to be mounted on a wall.
30906035	SANIT WC-Element 995 N BH 820 Bet. vorn / oben , kleine Revisionsöffnung	 A blue metal frame for a wall-mounted toilet element. It has a white panel with a central circular opening for the toilet bowl and a small rectangular opening at the top for a revision. The frame is designed to be mounted on a wall.
30906073	SANIT WC-Modul INEO Solo Bet.vorn kl Revisionsöffnung,schwarz/weiß BH 1126	 A blue metal frame for a wall-mounted toilet element. It has a white panel with a central circular opening for the toilet bowl and a small rectangular opening at the top for a revision. The frame is designed to be mounted on a wall.

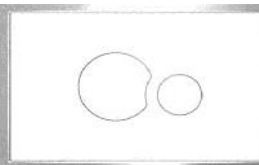
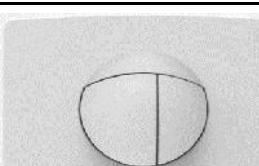
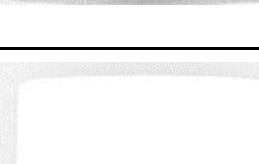
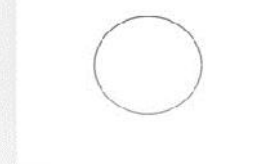

<p>17276000 Sanit Waschtischmodul für Einloch - und AP Armaturen B=444mm/T=85mm</p>	
<p>30906670 SANIT WT-Element INEO 1120mm für Einlocharmaturen</p>	
<p>30906180 SANIT Urinal-Element INEO Druckspüler UP Kartuschenventiltechn.m. Rohbauset</p>	
<p>30172140 SANIT Urinal-Rohbaukasten für Kartuschenventiltechnik</p>	
<p>30907005 SANIT Wandhalter (Set) für WT und WC Objektelment</p>	

46470601	SANIT Betätigungsplatte S706 weiß Bet.vorn/oben2-Mengensp.f.kl.Revisionsöffn.	
46470602	SANIT Betätigungsplatte S706 matt vc Bet.vorn/oben2-Mengensp.f.kl.Revisionsöffn.	
46470603	SANIT Betätigungsplatte S706 vc Bet.vorn/oben2-Mengensp.f.kl.Revisionsöffn.	
46470701	SANIT Betätigungsplatte S707 weiß eckig Bet.vorn/oben2-Mengensp.f.kl.Revisionsöffn.	
46473300	SANIT Betätigungsplatte LOS weiß/schwarz für kl. Revisionsöffnung	
46473308	SANIT Betätigungsplatte LOS schwarz/mattchrom für kl. Revisionsöffnung	
46473313	SANIT Betätigungsplatte LOS schwarz/weiß für kl. Revisionsöffnung	
46473316	SANIT Betätigungsplatte LOS chrom/weiß für kl. Revisionsöffnung	
46472601	SANIT Betätigungsplatte flächenbündig Kunststoff weiß, Rahmen Edelstahl pol.	
46472682	SANIT Betätigungsplatte flächenbündig Kunststoff schwarz, Rahmen Edelstahl pol.	
46401001	SANIT Betätigungsplatte weiß, Bet.vorn/oben 2-Mengensp./Start-Stopp f.kl.Revisionsöffn.	
46101001	SANIT Urinal - Abdeckplatte weiß f.Urinal-Element 995 Druckspüler UP	

30906162	Sanit Modul für Wannenrandarmatur	
30906163	Sanit Schlauchkasten mit Rückschlagklappe für Wannenrandarmatur	

SANIT Ersatzteile

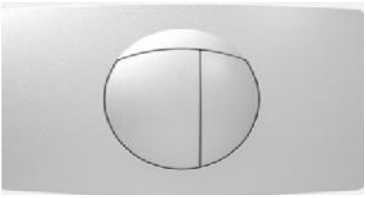
46098200	Sanit Ablaufg.für WC-Element INEO universal f UP Kästen mit 2 Kabeltechnik u Pneumatik	
46027700	Sanit Druckspirale für Ablaufgarnitur WC-Element INEO inkl. Kabelbox	
46027550	Sanit Druckspirale für Ablaufgarnitur WC-Element 995N - schwarz	
46027690	Sanit Druckspirale für Ablaufgarnitur WC-Element 995N - rot	
46030370	SANIT Druckspiralen-Set /2 Stück 1m,schwarz m.Klammer f. Ablaufgarnitur WC-Element 995N	
30906016	SANIT Baugruppe für Geruchsabsaugung INEO	
46027560	Sanit Klammer f. Druckspirale f. Ablaufgarn WC-Element 995N m. kl. Rev.öffnung	
46027580	Sanit Spülstromdrossel BH 1185 f. Ablaufg. WC-Element 995N m. kl. Rev.öffnung	
46027581	Sanit Spülstromdrossel zum nachträglichen Einbau in SANIT UP-Spülkästen	
46027590	Sanit Füllventilhalter f.WC-Element 995N m.kleiner Revisionsöffnung /Bet.vorn + oben	
46028790	Sanit Niederhalter f.WC-Elem. 995 Bet.vorn (f.Bef. UP - Spülkasten) ab Bj. 2003	
46028986	Sanit Blendrahmen 6 mm für Flächenbündige Bet platte	
46027540	Sanit Dichtring für alle AP + UP Spülkästen Ablaufgarnituren Ø31 x Ø64 x 2,8	

46304005	SANIT Betätigungsplatte chrom matt B.vorn 2-Mengen-Spülung	
46304000	SANIT Betätigungsplatte chrom Bet.vorn 2-Mengen-Spülung	
46203040	SANIT Betätigungsplatte weiß, Bet.vorn	

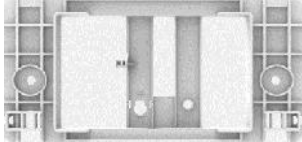
46010190	Sanit Einhängerahmen f. Betätigung 2-Mengen	
----------	---	---

46010200	Sanit Befestigungsset f. Betätigung 2-Mengen und Start / Stopp	
46012310	Sanit Schnellspannbefestigung (Paar) für WC-Elem. 995N m.kl.Rev-öffng /Bet.vorn+oben	

46012460	Sanit Auslaufeinrichtung für Spülkasten 936	
46014890	Sanit Auslaufeinrichtung für Spülkasten 937	

46018210	Sanit Kombischelle f. WC-Elem. 995 / 995N	
----------	---	---

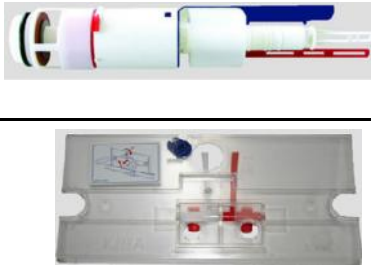
46019500	Sanit Ablaufgarnitur für WC-Element 995 2 - Mengen / Bet. vorn	
46019520	Sanit Scharnierplatte für WC-Element 995 2 - Mengen / Bet. vorn / inkl. 2 Hebel	

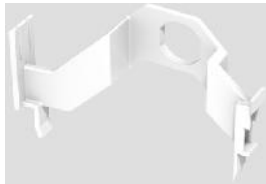
46023300	Sanit Haltebrücke für Spülkasten 937	
----------	--------------------------------------	---

46023960	Sanit Betätigungsbolzen f. Bet. Start/Stopp	
----------	---	---

46024240	Sanit Rundring d= 41 x 5 f. WC-Elem. 995 Bet. vorn	
46024360	Sanit Rundring d= 55 x 5 f. Ablaufgarnitur WC-Element 995 / 995N	
46024610	Sanit Lippendichtung d=45mm für WC-Element 995 / 995N	
46027530	Sanit Rundring d= 49 x 6 f. WC-Element 995N m.kleiner Revisionsöffnung / Bet.vorn+oben	

46026350	Sanit Riegel f. WC-Elem. 995 Bet.vorn	
----------	---------------------------------------	--

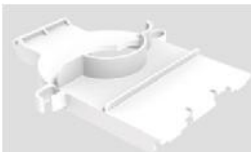
46027490	Sanit Niederhalter für WC-Element 995N m.kleiner Revisionsöffnung /Bet.vorn + oben	
----------	---	---

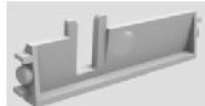

46029990	Sanit Brücke f.Bet-platte Start / Stopp runde Taste	
----------	--	---

46031250	Sanit Einhängerahmen f. Betätig.Start/Stopp	
----------	---	---

46031270	Sanit Blattfeder f. Betätigung 2-Mengen 2 Stück	
----------	--	---

46058211	Sanit Übergangsmuffe DN 90/DN100 schwarz	
----------	---	---

WISA

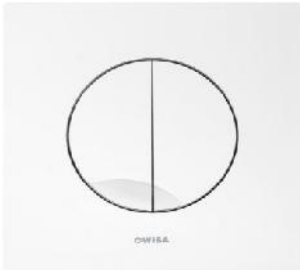

30452939 WISA WC-Element XS BH 1180/2-Mengen kpl. m.Bet.pl.weiß+Wandbef.+SS-Set Profiline	 A blue metal frame supporting a white WC element with a yellow flush valve and a stainless steel set of profiles.
30452721 WISA WT-Element XS BH 1180 mm Profiline Breite 380 mm mit Wandbefestigung	 A blue metal frame supporting a white WT element with a yellow flush valve and a stainless steel set of profiles.





30451440 WISA Betätigungsplatte weiß MARO DF für XS Element / 2-Mengen	 A circular diagram showing a circle divided into two halves by a vertical line, representing the MARO DF flush plate.
30451442 WISA Betätigungsplatte Glanz chrom MARO DF für XS Element / 2-Mengen	
30451443 WISA Betätigungsplatte matt vc MARO DF für XS Element / 2-Mengen	



WISA Ersatzteile



30453900	Aufnahmebock mit Umlenkhebel für WISA XS Spülkasten	
30453901	Set Montagestifte für WISA XS Betätigungsplatte DF 2-Mengen	
30458015	Auslaufventil zu WISA XS Spülkasten inkl. Bodenventildichtung	
30458870	Haltebrücke für Füllventil zu WISA XS Spülkasten	
30458871	Sicherungsclip zu WISA XS Spülkasten	
30458873	WISA UP Spülrohrbogen mit Lasche für Wisa XS Spülkasten	
30458879	Rohrschelle zu WISA XS Spülkasten	
30459884	Bodenventildichtung für WISA XS Spülkasten Loch 28,5mm	

46754029	WISA Universal-Füllventil für alle WISA Spülkästen	
30454280	Dichtungssatz für Wisa Universal Füllventil	
30458003	Hutmembran für Wisa Universal-Füllventil	

30451403	Eckventil 1/2" für alle AP/UP Spülkästen	
30452330	WISA Flexschlauch 1/2" mit Kugelabsperrhahn	



30453910	WISA Zugstange für Tank 2100 SU	
30453911	WISA Haltebrücke zu Tank 2100 mit Halter für Füllventil	
30455005	WISA Auslaufventil für Tank 2100 SU	
30458811	WISA Auslösehebel für 2100 SU	



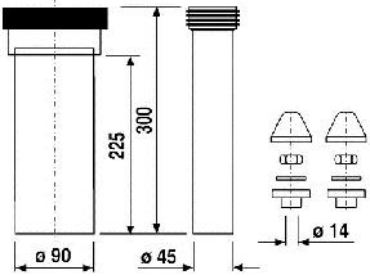

30454206	WISA Betätigungsplatte weiß 2100SU vorn für Tank 2100 SU	
30454216	WISA Betätigungsplatte weiß 2100DF vorn für Tank 2136 SU Zweimengentechnik	

30454236	WISA Betätigungsplatte weiß 2100 TOP	
30454226	WISA Mauerrahmen weiß für Tank 2102 TOP	

30455006	WISA Auslaufventil für Tank 2136 DF	
----------	-------------------------------------	---

Anschlussgarnituren

<p>30215820 Anschlußgarnitur für WWC UP DN 80 x 180 mit Abdeckzubehör weiß</p>	
<p>30215855 Anschlußgarnitur für WWC UP 300mm DN80 Abdeckung weiß</p>	
<p>30215892 Wand-WC Etagen Anschlußgarnitur DN 80</p>	
<p>30215800 Anschlußgarnitur für WWC UP m.Abdeckzubehör DN 100 x 155mm</p>	



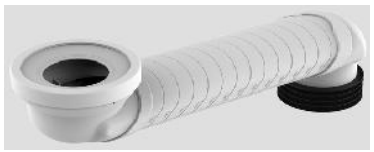

<p>30215833 Sanit WC-Anschlußstück DN 80/100 schw. VW</p>	
<p>30215834 Sanit WC-Anschlußstück DN 80 schwarz VW</p>	
<p>30215840 SANIT WC-Anschluß Bogen 90° DN 80/100 VW</p>	
<p>29326609 WC-Anschlußbog.DN 80 schw. 90° PE für Vorwand</p>	

58994000	WC-Anschlussrohr 45mm L= 300mm, Kunststoff PE schwarz	
58997000	WC-Anschlussrohr 45mm L= 400mm, Kunststoff PE schwarz	
30215700	SANIT Spülrohrverb.m. Anschlußrohr 155mm f. WC Elemente	

58111000	Sanit Versprungbogen Versprung 60mm-350mm	
----------	--	---

46660022	Urinal-Zulaufgarnitur RST 19mm x 1/2" AG und Gummi exzentrisch	
46660023	Dichtgummi zu Urinal-Zulaufgarnitur RST	

Sonstige Ersatzteile

46402131	Geberit Betätigungsplatte Sigma 01 weiß Zwei-Mengen Spülung	 A white rectangular flush plate with two circular buttons of different sizes, one larger than the other, for two-stage flushing.
46402121	Geberit Betätigungsplatte 300T weiß Betätigung von oben	 A white rectangular flush plate with a single large oval button on the top surface for top-actuation.
46402132	Geberit Betätigungsplatte 200F weiß Betätigung von vorn,Spül-Stopp-Funktion	 A white rectangular flush plate with a large oval button on the front surface, designed for front-actuation and including a flush stop function.
4675403G	Universal - Hebeglocke Geberit für UP Spülkästen	 A universal lift ring assembly consisting of a white plastic ring, a small metal clip, and a black metal support arm with a T-shaped top.
60005033	Grohe Betätigungsplatte Surf weiß, pneumatisch	 A white, square-shaped flush plate with a large oval button in the center, featuring a pneumatic actuation mechanism.

Druckspüler



Artikelnummer Bezeichnung

Abbildung

46660000	Urinal-Druckspüler 1/2" vc Nil plus Nova	
46660001	Urinal-Druckspüler 1/2"vc mit Vorabsperung Nil plus nova	

46660015	Urinal Innenverbinder für Spülrohr 18 mm mit Rosette	
46660021	Urinal-Zulaufgarnitur RST 19mm x 1/2"AG und Gummi	

46664560	Urinal-Spülrohr 300mm vc gerade für Druckspüler DK78	
46664561	Urinal-Spülrohr 300mm vc gekröpft 25mm versetzt für Druckspüler DK 78	
46664562	Urinal-Spülrohr 300mm vc gekröpft 30mm versetzt für Druckspüler DK 78	
46664563	Urinal-Spülrohr 300mm vc gekröpft 40mm versetzt für Druckspüler DK 78	
46664564	Urinal-Spülrohr 300mm vc gekröpft 50mm versetzt für Druckspüler DK 78	

46661000 WC-Druckspüler 3/4" vc	
46730288 WC Spülrohr für Druckspüler, leicht gekröpft verchromt	

Schwimmventil

Artikelnummer Bezeichnung

Abbildung

46754028 Universal-Füllventil 510

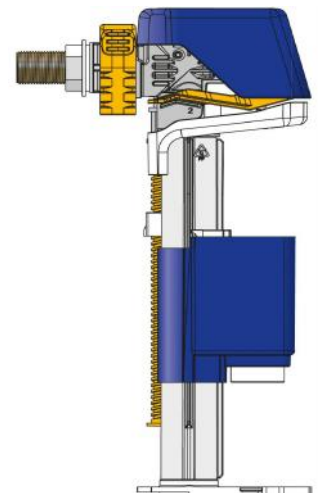

46754029 WISA Universal-Füllventil
für alle WISA Spülkästen



4675402G

Kompakt-Schwimmerventil Geberit
mit Wasseranschluß hinten für UP Kästen





Elektrospeicher

Artikelnummer Bezeichnung

Abbildung

48510005	Elektrospeicher Übertisch / ND 5L	
48515005	Elektrospeicher Untertisch /ND 5L	

0323.15.012	Sicherheitsgruppe 323 G1/2, 6 bar, verchromt	
0324.15.011	Sicherheitsgruppe 324 mit Druckminderer DN15, 6 bar, verchromt	

32325229	Sicherheitsgruppe INOX GS SFR 3/4" für Elektro-Speicher bis max 10KW 7 bar	
----------	---	---

14010003	Elektro Wandhängespeicher 30 Liter / 6 bar H= 490 x B= 500 x T= 500 Austria	
14010005	Elektro Wandhängespeicher 50 Liter / 6 bar H= 610 x B= 500 x T= 500 Austria	
14010008	Elektro Wandhängespeicher 80 Liter / 6 bar H= 830 x B= 500 x T= 500 Austria	

14010022	Kospel-Elektro Wandhängespeicher 20 Liter rund Durchm. 36 cm Höhe 37,6 cm	
14010023	Kospel-Elektro Wandhängespeicher 30 Liter rund Durchm. 36 cm Höhe 47,6 cm	
14010025	Kospel-Elektro Wandhängespeicher 50 Liter rund Durchm. 36 cm Höhe 76,6 cm	
14010028	Kospel-Elektro Wandhängespeicher 80 Liter rund Durchm. 36 cm Höhe 112,6 cm	

14010033	Objekt-E-Wandhängespeicher 30 Liter 1,5KW druckfest Höhe 600mm Durchmesser 340mm Wahlbach	
14010035	Objekt-E-Wandhängespeicher 50 Liter 1,5KW druckfest Höhe 755mm Durchmesser 385mm Wahlbach	
14010038	Objekt-E-Wandhängespeicher 80 Liter 2,0KW druckfest Höhe 796mm Durchmesser 450mm Wahlbach	

48515015	Elektrospeicher Untertisch 5 Ltr. druckfest	
48515020	Elektrospeicher Übertisch 5 Ltr. druckfest	
14010001	Elektro Kleinspeicher 10 Liter Untertisch 1,2 KW / 220/230 V (drucklos anschließbar)	
14010011	Elektro Kleinspeicher 10 Liter Übertisch 1,2 KW / 220/230 V (drucklos anschließbar)	

Durchlauferhitzer

Artikelnummer Bezeichnung

Abbildung

29115104	Klein - Durchlauferhitzer amicus 4 KW Untertisch druckfest	
29115106	Klein - Durchlauferhitzer amicus 6 KW druckfest 230/400V 2N~6Kw 0,6MPa	

29116091	Objekt - Durchlauferhitzer 18 / 21 / 24 KW elektronisch umstellbar, LCD Display	
----------	--	--

Badeofen

Artikelnummer Bezeichnung

Abbildung

49706000 Wittigstahl Badeofen komplett
für feste Brennstoffe / 100Ltr





WC Abläufe



Artikelnummer Bezeichnung



Abbildung

45750041	WC Anschlußrohr flexibel DN 100 weiß Länge 580 mm	
45750042	WC Anschlußbogen 22,5° weiß	
45750044	WC Anschlußbogen 45° weiß	
45750049	WC Anschlußbogen 90° weiß	
45750701	WC Anschlußbogen Universal 0-90° DN100 weiß	
45765042	WC Anschlußbogen 90° DN 100 weiß mit 2 Anschlüssen DN 50	
45765040	WC Anschlußbogen 90° DN 100 weiß mit zusätzl. Stutzen oben DN40/50	
45765043	WC Anschlußbogen 90° DN 100 weiß mit zusätzl. Stutzen links DN 40/50	
45765044	WC Anschlußbogen 90° DN 100 weiß mit zusätzl. Stutzen rechts DN 40/50	
45751041	WC Anschlußstutzen 150 mm weiß	
45751042	WC Anschlußstutzen 250 mm weiß	
45751044	WC Anschlußstutzen 400 mm weiß	
45761040	WC Anschlußstutzen m.seitl. Anschluß DN 50, weiß	
45761140	WC Anschlußstutzen seitl.Abgang DN40/50 400 mm weiß	
45760040	WC Anschlußstutz.exzentr.DN 100 weiß	

45112103	WC Lippendichtung für WC-Anschlussbögen und -stutzen	
----------	--	---

45753040	WC Rosette weiß	
45752040	WC Klapprossette weiß	

45762001	WC-Anschlußgummi DN 100 gerade weiß	
45762002	WC-Anschlußgummi DN 100 versetzt weiß	

46765001	SANIT Unitasmanschette DN 30 x 67	
46765002	SANIT Unitasmanschette DN 40 x 74	
46765005	SANIT Euromanschette DN 40	
46765006	SANIT Euromanschette DN 32	

WT Abläufe

Artikelnummer **Bezeichnung**

Abbildung

59052000	Röhrensifon 1 1/4 x 1 1/4 vc	
59052200	Röhrensifon 1 1/4 x 1 1/4 Edelstahl V2A vc	

59060000	Röhrensifon 1 1/4 Kst.	
----------	------------------------	---

59060021	Röhrensifon mit Geräteanschluß 1 1/4x40	
59060020	Röhrensifon mit Geräteanschluß 1 1/4x50	

59052003	Röhrensifon 1 1/4 x 32 mm ABS verchromt	
----------	--	---

59289553	Röhrensifon "Raumschaffer f. WT" 1 1/4x32 Kst.	
----------	--	---



59054000	Flaschensifon 1 1/4x1 1/4 vc	
59054001	Flaschensifon 1 1/4 x 1 1/4 vc, Verl.Rohr120mm	



59052001	DESIGN Röhrensifon 1 1/4 vc leichte Ausführung - gesteckt	
----------	--	---

59260040	SANIT Aufputz - Geruchsverschluß für WT 1 1/4" x40 waagerecht Kst.behindertengerecht	
----------	---	--

59264038	SANIT Wandeinbau - Geruchsverschluß m.Ablaufbogen vc für WT 1 1/4" x 40/50 beh.	
----------	--	---

59073002	Verstellrohr 1 1/4x40x200 Kst.	
----------	--------------------------------	---

45102371	Muffe DN 32 vc	
45105488	Kupplung DN 32 vc	
3500000	T-Stück Messing vc DN32 zum Verbinden v.2Geruchsverschlüssen	

45109189	Abgangsbog.90°32x220,m.Bör.vc	
45109188	Abgangsbog.90°32x250,m.Bör.vc	
45109190	Abgangsbog.90°32x300,m.Bör.vc	
45109191	Abgangsbog.90°32x300,m.Bör.vc für UP Sifon mit 1 1/4" Überwurf	

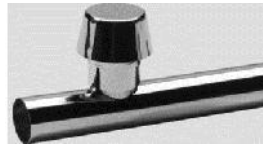
45119942	Abgangsbogen 90° mit RB 32 x 250 vc	
45119941	Abgangsrohr für Flaschensifon mit RB 32 x 250 vc	

59065200	Bördelrohr 32 x 200 vc	
59065300	Bördelrohr 32 x 300 vc	
59065500	Bördelrohr 32 x 500 vc	
59065220	Bördelrohr 32 x 200 Edelstahl vc	
59065330	Bördelrohr 32 x 300 Edelstahl vc	

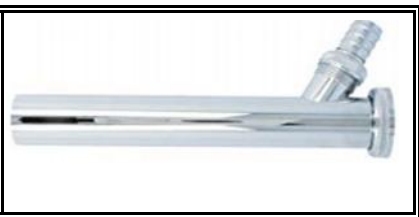
59071002 Verstellrohr 1 1/4" x 200mm m.Geräteanschl. vc	
--	---

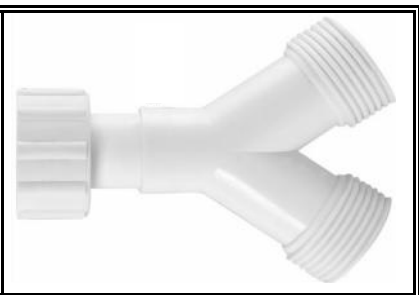
59071030 Schlauchanschl.doppelt 45°3/4"ÜM + 2x3/4"AG weiß pass.an Bördelrohr m.Schlauchver.vc	
---	---

59050907 Rosette 32 x 80 x 24 MS / vc	
59050908 Rosette 32,5x85x50 vc	
42377900 Rosette 32 x 87 x 45 MS / vc	
42127000 Rosette 32 x 90 x 40 MS / vc	

<p>40559558 Ablaufgarnitur "Push & Open", 1 1/4", rund</p>	
<p>40500710 Ablaufgarnitur "Push & Open", 1 1/4", eckig</p>	
<p>40559561 Ablaufgarnitur Design-Schaftventil 1 1/4"vc nicht verschließbar 80mm f. WT ohne Überlauf</p>	
<p>40559551 Ablaufgarnitur 1 1/4" für EHM WT vc</p>	
<p>40559550 Excenterstopfen für EHM WT vc</p>	
<p>43559559 Ablaufgarnitur 1 1/4" INEO FLUX m. Platte vc für Möbel WT ohne Überlauf komplett</p>	

Spülen Abläufe

Artikelnummer **Bezeichnung**

Abbildung

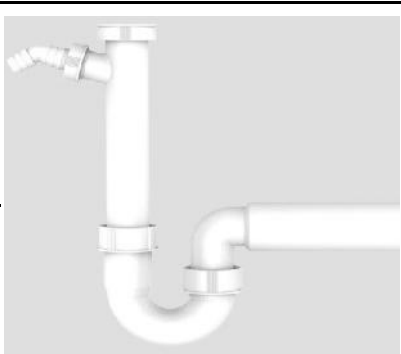
59060030	Röhrensifon mit Geräteanschluß 1 1/2x50	
59060031	Röhrensifon mit Geräteanschluß 1 1/2x40	

59280100	SANIT Ab-u.Überlaufgarn Doppelspüle mit Geräteanschluß 1 1/2 x 40 x 210-250	
----------	---	--

59281040	Röhrensifon Kunst.1 1/2x40	
59281050	Röhrensifon Kunst.1 1/2x50	

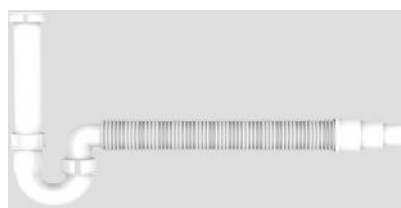

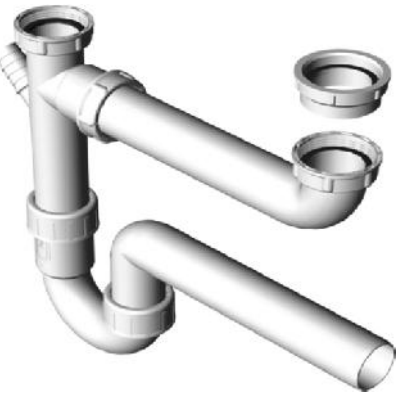



59281150	Röhrensifon 1 1/2x 40/50 mit flexibel Abgang u.Gerätanschl. Kst.weiß	
----------	--	---

59282040	Röhrensifon Doppelpüle 1 1/2x40	
59282050	Röhrensifon Doppelpüle 1 1/2x50	

59284000	Ab-u.Überlaufgarn. für Spüle mit Überlaufrohr 1 1/2" x 70	
----------	---	--

59289551	Röhrensifon "Raumschaffer" 1 1/2x40 mit Geräteanschluss	
59289552	Röhrensifon "Raumschaffer" 1 1/2"x50 mit Geräteanschluss	

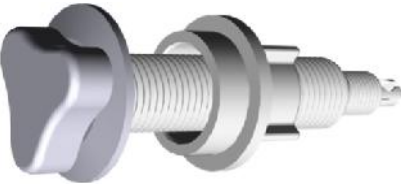

59282070	VIEGA Ab-u.Überlaufgarn.für Doppelpüle Raumschaffer 1 1/2" Ablaufloch 70	
----------	--	---

45118426	Abgangsbogen 90° mit RB 40 x 220 Kst	
59072003	Verstellrohr 1 1/2 Kst. 250 mm DN 40	
59072000	Verstellrohr 1 1/2 1 Schlauchver. Kst.	
59072001	Verstellrohr 1 1/2 2 Schlauchver. Kst	
59578893	Ablaufventilset Spüle für Ablaufloch 90 mit Bowdenzug komplett	
59577445	VIEGA Drehbetätigung für Bowdenzugmutter aus Kunststoff	
59678586	VIEGA Bowdenzug für Spüle mit Kstmutter	
59680695	VIEGA Körbchenventil aus Edelstahl f. Spüle m.Ablaufloch 90 u.Bowdenzugmechanik	

Geräteanschlüsse



Artikelnummer **Bezeichnung**



Abbildung

59294040	Trichtersifon DN 40	
59294050	Trichtersifon DN 50	
250125TS	Trichtersifon passend für DN 50, 110, 125 und DN 110 Spitzende	

59283140	Geräteanschluß AP DN 40 Röhrensifon mit Schlauchversch.	
59283150	Geräteanschluß AP DN 50 Röhrensifon mit Schlauchverschraubung	

59264037	SANIT UP Geruchsverschluß mit Wasserzulauf komplett	
----------	--	--

59264050	SANIT Geräteanschluß UP 40/50 Kastensifon m. Schlauchverschraubung	
59278000	SANIT Geräteanschluß AP DN 40/50 senkr. Kastensifon m. Schlauchverschraubung	

59264040	VIEGA Geräteanschluß UP DN 40/50 Kastensifon m. Schlauchverschr.	
59276000	VIEGA Geräteanschluß AP DN40 waag. Kastensifon mit Schlauchverschr.	
59277000	VIEGA Geräteanschluß AP DN40/50 senk. Kastensifon mit Schlauchverschr.	

59264041	VIEGA Ausstattungsset vc für Geräteanschluß UP	
----------	---	---



Zubehör für WT-, Spülen- und Geräteanschlüsse

Artikelnummer Bezeichnung



Abbildung

59020000	Uni-Stopfenventil 1 1/4	
59021000	Uni-Stopfenventil 1 1/2	



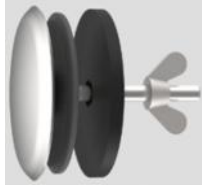

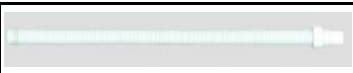
59011001	Ventilstopfen WT Kst Dreiecköse 38,5mm	
59011004	Ventilstopfen 40,5 mm	
59011002	Ventilstopfen Sp/W Kst Dreiecköse 43,5mm	
59011003	Ventilstopfen Sp/W Kst Dreiecköse 45,5	
59011005	Ventilstopfen 50,5 mm	

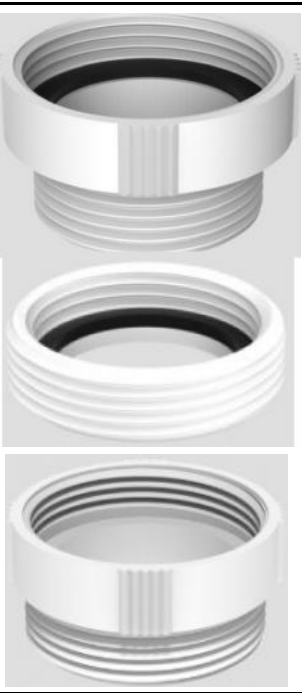

40311098	Kettenhalter mit Kugelkette 500 mm für Standventil mit Standhahnring - eckig	
40311099	Kettenhalter mit Kugelkette 250 mm für Standventil mit Standhahnring	
59012000	Kugelkette 250mm für Waschtisch	
59011998	Kugelkette 500mm für Badewanne	

59098000	Hahnlochstopfen Spüle 1/2 vc	
59099010	Hahnlochstopfen WT vc	

59141100	Flexibles Anschlußrohr DN 40x650mm	
59141200	Flex. Anschlußrohr DN40/50 mit 90° Bogen, Länge 500 mm	

59141300	Sanit ÜG-Stück 1 1/2 IG ,1 1/4 AG m.D.weiß	
59141310	Sanit ÜG-Stück 2 IG, 1 1/2 AG Kst,weiß	
59141320	Sanit ÜG-Stück 1 1/4 IG ,1 1/2 AG m.D.weiß	
59141400	Sanit Höhenausgleichsstück 1 1/2 IG/AG	

59071010	VIEGA Schlauchverschr.45° 1 Anschl. ÜM 1"	
59071020	VIEGA Schlauchverschr.45° 2 Anschl. ÜM 1"	
59071110	VIEGA Schlauchverschr.90° 1 Anschl. ÜM 1 1/4"	
59071040	Geräteanschlussstülle 90° mit Kondensatanschluss	
59066040	Verlängerungsstück 1 x 50 geeignet für Geräteanschluß	

59050512	Rosette 50x90x25 Kst. weiß	
59050513	Rosette 50x90x30 Kst. weiß	
59090511	Rosette 40x80x35 Kst. weiß	
59097400	VIEGA Verschlussrosette Kst.90x32 weiß	

Bidet Ablauf

Artikelnummer Bezeichnung

Abbildung



59045000 Bidet Röhrensifon 1 1/4 vc	
-------------------------------------	--





Ablaufgarnituren Duschen



Artikelnummer Bezeichnung







Abbildung

59070060	Profiline Ablaufgarnitur f.Dusche Abdeckplatte vc für Ablaufloch 90mm	
----------	---	---

59162001	SANIT Ablaufgarn.f.Dusche 821/50 Abdeckplatte vc	
59162011	SANIT Abdeckplatte für Ablaufgarnitur Dusche 821/90	
59162000	SANIT Ablaufgarnitur 826 für Dusche für Ablaufloch 50mm, mit Standrohr	

59162010	SANIT Ablaufgarn.f.Dusche 823/90 Abdeckplatte vc für Ablaufloch 90mm	
59162020	SANIT Ablaufgarn.f.Dusche 823/90 senkrecht Abdeckplatte vc für Ablaufloch 90mm	
59162110	SANIT Ablaufgarn.f.Dusche flach 60mm 823/90 Abdeckplatte vc für Ablaufloch 90mm	
59162009	SANIT Abdeckplatte f. Ablaufg.Dusche 823/90 FW + FS chrom	



59157000	VIEGA DOMOPLEX vc 6928	
59157001	Viega Domoset vc zur Fkt.einheit 6928 Für Duschwannen mit 52 mm Ablaufloch	

59195000	VIEGA TEMPOPLEX vc 6961 komplett für flache Duschwannen mit Ablaufloch 90mm	
59195010	VIEGA TEMPOPLEX vc 6963 superflach EBH 60mm komplett für Duschw. mit Ablaufloch 90mm	
59155003	VIEGA TEMPOPLEX vc 6962 komplett Abg.senkr für flache Duschwannen mit Ablaufloch 90mm	
59155001	VIEGA TEMPOSET vc zur Fkt.einheit 6964.0 Ablaufloch 90mm ab Baujahr 2006 3 Schrauben	
59155101	VIEGA TEMPOSET vc zur Fkt.einheit Ablaufloch 90mm ab Bj.2001 2 Schrauben 6958.99	
59155111	VIEGA TEMPOSET vc zur Fkt.einheit Ablaufloch 90mm Bj.1991-2001 6 Stege 6956.0	

Ab-, Ein- und Überlaufgarnituren für
Wannen

Artikelnummer **Bezeichnung**

Abbildung

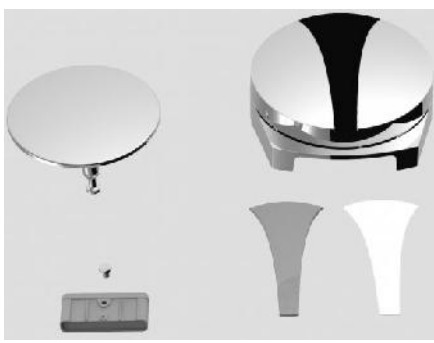
<p>59167010</p> <p>SANIT Ab-u.Überlaufgarn.Swing Plus für Wanne m.Zulauffunktion, Drehgriff rückstellbar vc komplett mit Bedieneinheit</p>	 A white plastic overflow assembly for a bathtub. It features a curved pipe with a drain at the bottom and a vertical pipe that rises and then curves back down to a circular shower head. A black control knob is located on the vertical pipe.
<p>59167011</p> <p>Sanit Ab-u.Überlauf Funktionseinheit lang Swing Plus m.Zulauffunktion,110-700mm</p>	 A white plastic overflow assembly, similar to the first one but with a longer vertical pipe section. It includes a drain, a shower head, and a control knob.
<p>59167012</p> <p>Sanit Bedieneinheit für Swing Plus chrom</p>	 A collection of chrome-plated components. It includes a circular shower head, a rectangular control knob, a large circular overflow plate with a central drain, and two funnel-shaped pieces, one white and one chrome.

59158000

VIEGA CITAPLEX mit Ventilstopfen 6176.45



59169001

VIEGA MULTIPLEX Funktionseinheit
5 Stege 6162.1 Neu



59161000

VIEGA MULTIPLEX Fkt.einheit 6163.2 lang
für Sondermodelle DN 40/50 - 1070mm



59170001

VIEGA MULTISSET vc zur Fkt.einheit
passend zur Multiplex Funktionseinheit neu
6162.01M5



<p>59191000 VIEGA MULTIPLEX TRIO Funktionseinh. 6161.22</p>	
<p>59191001 VIEGA MULTIPLEX TRIO Funktionseinh. lang, Bowdenzuglänge 725 mm 6161.32</p>	
<p>59192000 VIEGA MULTISSET TRIO vc zFkt.Einh. 6161.05</p>	
<p>59192010 VIEGA Anschlussgarnitur 6161.9 für Zulauf an der Multiplex Trio</p>	

59200001	VIEGA Dichtung für Ventilkegel für Multiplex und Multiplex Trio	
59200000	VIEGA Ventilkegel vc 6162.03 für Multiplex und Multiplex Trio	
59193000	VIEGA UP Rohrunterbrecher 3/4 6161.81	
59119188	VIEGA MULTIPLEX T-Stück Modell 6895 für den Tropfwasseranschluß am Überlaufrohr	

Ablaufgarnituren für Urinale

Artikelnummer **Bezeichnung**

Abbildung

45705000 Urinal Röhrensifon DN 50x40 7985.94



45705001 Urinal Flaschensifon DN50x40 5725.94







45705002 Urinal Absaugformstück DN 50 Kst.weiß
waagrecht und senkrecht



45705003 Urinal Absaugformstück DN 50/40 waagrecht





<p>46662374 Urinalsieb universal Edelstahl passend für alle gängigen Urinale</p>	
<p>46662381 Zange für Urinalsieb universal Edelstahl</p>	
<p>46660022 Urinal-Zulaufgarnitur RST 19mm x 1/2" AG und Gummi exzentrisch</p>	
<p>46660023 Dichtgummi zu Urinal-Zulaufgarnitur RST</p>	

Kleinraumlüfter

Artikelnummer Bezeichnung

Abbildung

00072000	Einbaulüfter iCON 15 weiß 68m³/h 230V Auslass 100 mm für Wand- und Deckenmontage	
00072001	Einbaulüfter iCON 30 weiß 118m³/h 230V Auslass 100 mm	
00072002	Einbaulüfter iCON 60 weiß 260m³/h 230V Auslass 150 mm	

00072021	iCON Timer Modul TM einstellbare Nachlaufzeit 1-45min	
00072023	iCON Feuchte Modul HTM Luftfeuchteregler 40-90% + Nachlaufzeit 1-45min + Zugschnur	
00072024	iCON Bewegungsmelder Modul PRTM und Timer zur einstellbaren Nachlaufzeit	
00072025	iCON Bewegungsmelder, Feuchteregler Modul PRHTM und Timer zur einstellb. Nachlaufzeit	
00072195	iCON Timer Modul DTM Startverzögerung 2min und einstellbare Nachlaufzeit 1-45min	

00072042	iCON Kondensatfalle Durchmesser 100mm	
----------	---------------------------------------	---

00072156	iCON Flex-Rohr Set Durchmesser 100mm 3m lang mit rechteckigem Ausblasgitter weiß	
00072157	iCON Flex-Rohr Set Durchmesser 100mm 3m lang m.rechteck.Ausblasgitter terracotta	
00072158	iCON Flex-Rohr Set Durchmesser 150mm 3m lang mit rechteckigem Ausblasgitter weiß	
00072159	iCON Flex-Rohr Set Durchmesser 150mm 3m lang m.rechteck.Ausblasgitter terracotta	

00780031	Entlüftungsgitter V2A mit Insektengitter und Federhalterung von 80-125	
----------	---	--

50195981	Einzelraumlüftungsanlage Vento Expert A50-1 Pro mit Wärmerückgewinnung ET 240-500mm	
----------	--	---