

HEIZUNG

1 Heiztechnik



2 Speicher



3 Solartechnik



4 Heizungsarmaturen



5 Pumpengruppen & Zubehör



6 Ausdehnungsgefäße



7 Heizungsumwälzpumpen und Zubehör



8 Schnellmontagetechnik / Edelstahl - Wellrohr



9 Zubehör und Kesseltechnik



10 Abgassysteme



11 Universal PHK



12 Bad HK



13 HK Befestigung



14 HK Ventile und Zubehör



15 Fußbodenheizung



16 Sockelleisten



Heiztechnik

Gas - Anlagen



Ölkessel



Festbrennstoff - Anlagen



Regelungstechnik





Warmwasserspeicher stehend

Artikelnummer Bezeichnung

Abbildung

14020012	Standspeicher 120 Liter - siber isoliert H= 913 mm / D= 600 mm	
14020016	Standspeicher 160 Liter - siber isoliert H= 1118 mm / D= 610 mm	
14020020	Standspeicher 200 Liter - silber isoliert H= 1340 mm / D= 610 mm	
14020030	Standspeicher 300 Liter - silber isoliert H= 1797 mm / D= 610 mm	
14020040	Standspeicher 400 Liter - silber isoliert H= 1832 mm / D= 680 mm	
14020050	Standspeicher 500 Liter - silber isoliert H= 1838 mm / D= 760 mm	

48511004	Speicher-Flanschdichtung 8-Loch / FD180 Lochkreis150 mm für Austria Speicher	
----------	---	---

14020210	Standspeicher 120 Liter - silber isoliert H= 1120 mm / D= 518 mm ERSS 120	
14020220	Standspeicher 140 Liter - silber isoliert H= 1270 mm / D= 518 mm ERSS 150	

14025020	Standspeicher für Thermen 115l weiß Hochleistungsregister, mit Tauchhülse	
14025030	Standspeicher für Thermen 150l weiß 1,2 m2 Heizfläche, mit Tauchhülse	

Warmwasserspeicher liegend

Artikelnummer Bezeichnung

Abbildung

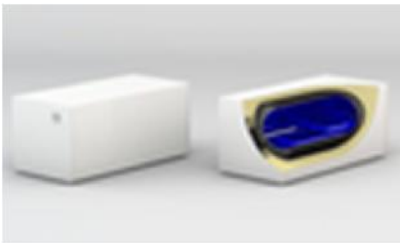
14022015	Unterbauspeicher 150 Liter - weiß H= 575 mm / B= 600 mm / L= 1030 mm	
14022020	Unterbauspeicher 200 Liter - weiß H= 575 mm / B= 600 mm / L= 1230 mm	

Solarspeicher

Artikelnummer Bezeichnung



Abbildung

14021030	Solarspeicher 300 Liter - silber isoliert H= 1797 mm / D= 610 mm	
14021040	Solarspeicher 400 Liter - silber isoliert H= 1832 mm / D= 680 mm	
14021050	Solarspeicher 500 Liter - silber isoliert Austria H= 1838 mm / D= 760 mm	

Pufferspeicher

Artikelnummer Bezeichnung



Abbildung

14030050	Pufferspeicher 500 Liter - ohne Isolierung	
14030080	Pufferspeicher 800 Liter - ohne Isolierung	
14030100	Pufferspeicher 1000 Liter - ohne Isolierung	
14030150	Pufferspeicher 1500 Liter - ohne Isolierung	
14030200	Pufferspeicher 2000 Liter - ohne Isolierung	
14031050	Pufferspeicher 500 Lt.o.Iso m.Rohrregister	
14031080	Pufferspeicher 800 Lt.o.Iso m.Rohrregister	
14031100	Pufferspeicher 1000 Lt.o.Iso m.Rohrregister	
14031150	Pufferspeicher 1500 Lt.o.Iso m.Rohrregister	
14035050	Isolierung für Pufferspeicher 500 Liter	
14035080	Isolierung für Pufferspeicher 800 Liter	
14035100	Isolierung für Pufferspeicher 1000 Liter	
14035150	Isolierung für Pufferspeicher 1500 Liter	
14035200	Isolierung für Pufferspeicher 2000 Liter	

Sicherheitsgruppen

Artikelnummer Bezeichnung

Abbildung

0024.15.002	SYROBLOC-Sicherheitsgruppe 24 DN15, 10 bar, rohgelb, G1/2	
0024.20.002	SYROBLOC-Sicherheitsgruppe 24 DN20, 10 bar, rohgelb, G3/4	
0024.20.011	SYROBLOC-Sicherheitsgruppe 24 DN20, 10 bar, rohgelb, G1	
0025.15.000	SYROBLOC-Sicherheitsgruppe 25 DN15, 6 bar, rohgelb, G1/2	
0025.20.002	SYROBLOC-Sicherheitsgruppe 25 DN20, 10 bar, rohgelb, G3/4	

Zubehör Gefäße

Artikelnummer Bezeichnung

Abbildung

71712000	Reflex Spannbandset für Gefäße von 8 - 25 Ltr	
----------	--	---



76440000	Automatische Schnellkupplung 3/4 MAG	
----------	--------------------------------------	---

71715300	Kappenventil 3/4"	
71715400	Kappenventil 1"	

71720900	Gefäßanschlußgruppe	
----------	---------------------	--

91167990	Durchströmungsarmatur "Flowjet" zur Absperrung u. Entleerung von durchstr. ADG	
----------	---	---

76495200	Thermostatischer BW Mischer TBM 15 1/2	
76495201	Thermostatischer BW Mischer TBM 20/3/4"	
76495300	Thermostatischer BW Mischer MMV-S 20/3/4" geeignet f Solar Heißwasserzufuhr bis 110°C	

4807.20.000	Sicherheitscenter 4807;Sicherheitsgruppe mit Durchströmungsarmatur und MAG 12ltr g.	
00024472	Sicherheitscenter Securfix NG 4807 SV 10bar mit Durchströmungsarmatur und MAG 12 Ltr	
00024572	Sicherheitscenter Securfix NG 4807 SV 10bar mit Durchströmungsarmatur und MAG 18 Ltr	

70572040	Magnesiumanode 3/4 Länge 700 mm MAV 20/700	
70572070	Magnesiumanode MAD 26 / 500 mit Gewindenippel M 8 x 30	
70573210	Magnesiumanode 1 1/4 Länge 400 mm	
70573230	Magnesiumanode 1 1/4 Länge 550 mm	
70592080	Magnesiumanode,Kette mit 5 Gliedern 3/4 Länge 800mm / MAK 20/800	

Solar - Aufdachmontage

Artikelnummer **Bezeichnung**

Abbildung

17700778 Wolf Flachkollektor CFK1 2,3 qm
L= 2099 mm / B= 1099 mm / H= 110 mm

17701671 Wolf Aufdachmontageset für 3 Kollekt. CFK-1
hochkant bestehen aus
10 Stück Haken
Montageschienen 5er Set
Kollektorschienen Set für 3 Kollektoren

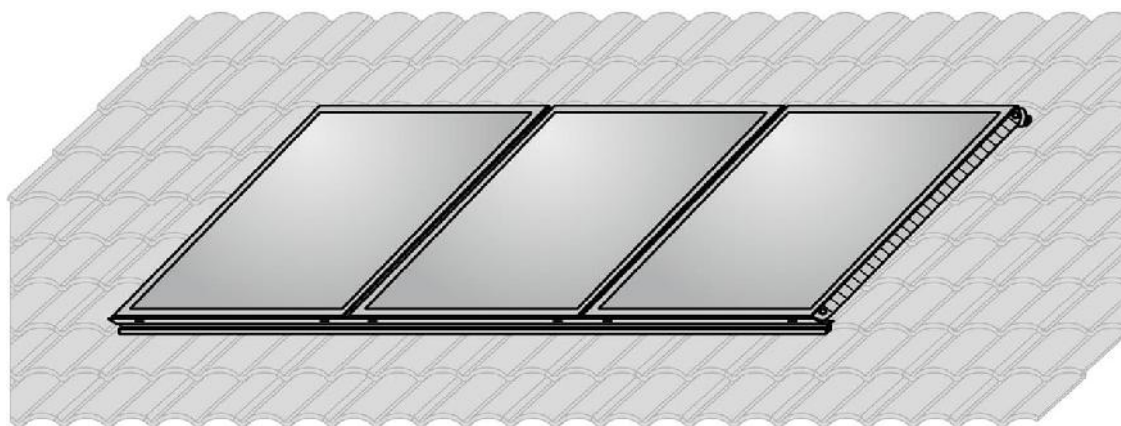

12483481 Wolf Montageschienenverbinder á 2 Stück zum
Verbinden von 2 Aufdach-Montagesets

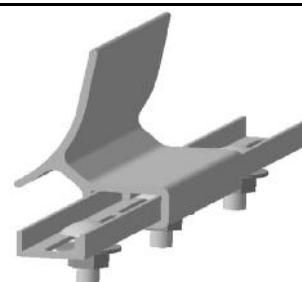

Solarpumpengruppen

Artikelnummer Bezeichnung

14130002	Zweistrang Solarstation m. Wilo YonosPara ST 15/7 PWM DN20 m. Entlüfter u. Ausdehnungsset	
23457056	Zweistrang Solarstation ohne Pumpe inkl. Permanententlüfter	

Solarregeler

Artikelnummer Bezeichnung











Abbildung

14140002	Einkreis- Solarregler SDR 2 zur Ansteuerung von 1 Kollektorfeld + 1 Speicher	
14140003	Mehrkreisregler Vision SDR3/3 Relaisausgä. 3Fühler (2xSpeicherf. PT1000+1Kollektorf.)	
14140006	Temperaturfühler PT1000 für Regelung SDR 2 bis SDR 6 hellgrau	
14140007	Kollektorfühlerfühler PT1000 für Regelung SDR 2 bis SDR 6 schwarz	
14140016	Mehrkreisregler Vision SDR6 + ohne Fühler	
14149484	Solar-Differenzregler Seltron SGC 16H zur Ansteuerung 1 Kollektorfeld +1 Speicher	

Montagezubehör

Artikelnummer **Bezeichnung**

Abbildung

12000030	Wolf Kompensator Kollektor Verschraubung	
12444050	Wolf Solar Entlüftertopf 0,15 Ltr. isoliert	
12482410	Wolf Anschlussset für 1 Kollektorfeld für Aufdach- und Indachmontage	
127442002	Wolf Frostschutzprüfer Messspindel "ANRO"	
13501521	Wolf Wärmeträgermedium Anro 10KG	
13501522	Wolf Wärmeträgermedium Anro 30KG	
14110381	Solar Spül-Befüll u.Entleerarmatur 3/4" Euro QuickFill	
14110383	Solar Spül-Befüll u.Entleerarmatur 1" AG QuickFill	
14129016	Membran Sicherheitsventil 1/2 6.0 bar solar	
14110512	Solar Sicherheitsgruppe SSG6 3/4"AGx3/4"ÜM SV 6bar	
14130008	Solar Schnellentlüfter MV15/Sol 1/2"-160°C	
14130001	Edelstahl - Wellrohrentlüfterset a`2 Stück mit Solarentlüfter absperribar	
14130004	Solarausdehnungsgefäß ADG 24 Liter / 8 bar (2,5 bar Vordruck)	

Solarisolierung

Artikelnummer **Bezeichnung**

Abbildung

68130182	Isolierung Solar EPDM 18 x 13 / 50%	
68190151	Isolierung Solar insul HT 15 x 19 / 50%	
68190181	Isolierung Solar insul HT 18 x 19 / 50%	
68190221	Isolierung Solar insul HT 22 x 19 / 50%	
68190281	Isolierung Solar insul HT 28 x 19 / 50%	
68250151	Isolierung Solar insul HT 15 x 25 / 100%	
68250181	Isolierung Solar insul HT 18 x 25 / 100%	
68250221	Isolierung Solar insul HT 22 x 25 / 100%	
68250281	Isolierung Solar insul HT 28 x 25 / 100%	

Membran Sicherheitsventile

Artikelnummer Bezeichnung

Abbildung

76503102	Membran Sicherheitsventil 1/2 2.5 bar	
76503103	Membran Sicherheitsventil 1/2 3,0 bar	
76503106	Membran Sicherheitsventil 1/2 6.0 bar	
76503110	Membran Sicherheitsventil 1/2 10 bar	
76503202	Membran Sicherheitsventil 3/4 2.5 bar	
76503206	Membran Sicherheitsventil 3/4 6.0 bar	
76503210	Membran Sicherheitsventil 3/4 10 bar	
76503302	Membran Sicherheitsventil 1 2,5 bar	
76503306	Membran Sicherheitsventil 1 6,0 bar	
76503310	Membran Sicherheitsventil 1 10 bar	
76503402	Membran Sicherheitsventil 1 1/4 2.5 bar	
76503406	Membran Sicherheitsventil 1 1/4 6.0 bar	
76503410	Membran Sicherheitsventil 1 1/4 10 bar	

76503125	Membran Sicherheitsventil 1/2 2.5 bar mit Manometer	
76503130	Membran Sicherheitsventil 1/2 3.0 bar mit Manometer	

Schnellentlüfter

Artikelnummer Bezeichnung

Abbildung

76552000	Schnellentlüfter Airvent AV15 1/2 6bar Eck	
----------	--	---

76554000	Schnellentlüfter Microvent MKV 10 R 3/8	
76554500	Schnellentlüfter Microvent MKV 15 R 1/2	

76554001	Schnellentlüfter Intervent 10 R 3/8	
76554501	Schnellentlüfter Intervent 15 R 1/2	

Thermometer

Artikelnummer **Bezeichnung**

Abbildung

76800063	Bimetall Anlegethermometer TAB 63/120 0 - 120°	
76800080	Bimetall Anlegethermometer TAB 80/120 0 - 120°	
76800086	Speicher Thermometer 80/100 m.Tauchhülse	
76800064	Bimetall Zeigerthermometer T 63/50 0-120°	
76800090	Thermo-Manometer 1/2" TM 80 /0-120°C/0-4bar	
76801400	Fernthermometer Digital mit 3m Sonde	
76801500	Fernthermometer 0-120° TER 40/150 eckig	
76801600	Fernthermometer 0-120° TC 50/100 rund	

76810100	Maschinenthermometer gerade 50mm MTG 50	
76811100	Maschinenthermometer gerade 63mm MTG 63	
76811150	Maschinenthermometer winklig MTW 50	
76863831	Abgasthermometer 0 - 500 °C / 300mm	
76863831	Abgasthermometer 0 - 500 °C / 300mm	
71855001	Tauchhülse f.Speicherfühler R1/2 7mm Gesamtlänge 100mm	
76800200	Tauchhülse TH R1/2" Gesamtlänge 50 mm	
76800201	Tauchhülse TH R1/2" Gesamtlänge 150mm	
76800202	Tauchhülse f.therm.Ablaufsicherung TH15/142	
76800203	Tauchhülse TH R1/2" Gesamtlänge 100mm	
76800204	Tauchhülse TH R1/2" Gesamtlänge 200mm	

Kesselsicherheitsgruppen

Artikelnummer **Bezeichnung**

Abbildung

76458300 Kesselsicherheitsgruppe KSG 30/E ohne Isolierung	 A brass safety valve assembly consisting of a pressure gauge on the left, a central safety valve with a black top, and a red-capped valve on the right, all mounted on a horizontal brass base.
---	---

76458301 Kesselsicherheitsgruppe KSG 30/ISO 2 mit Isolierung	 The same brass safety valve assembly as in the first image, but it is mounted on a rectangular block of white, porous insulation material.
--	--

76458302 Kesselsicherheitsgruppe KSG 30/N kompakte Montageinheit mit Isolierung	 A compact version of the safety valve assembly where the pressure gauge is integrated into the main body of the valve, and the entire unit is encased in a white, porous insulation shell.
---	--

Manometer

Artikelnummer Bezeichnung

Abbildung

76569100	Manometer-Absperrhahn 1/2 RM 15-MM	
76830000	Heizungsmanometer MHR 63/4 x 3/8 radial	
76830010	Heizungsmanometer MHR 63/4 x 1/4 radial	
76830020	Heizungsmanometer MHA 63/4 x 3/8 axial	
76830030	Heizungsmanometer MHA 63/4 x 1/4 axial	
76835006	Manometer 0- 6bar MDR 63/ 6 x 1/4 radial	
76835010	Manometer 0-10bar MDR 63/10 x 1/4 radial	
76835110	Manometer 0-10bar MDA 63/10 x 1/4 axial	
76838025	RF Manometer/Hydrometer MYR 80/25 0-2,5 bar, 0-25m Wassersäule 1/2"	
76839025	RF Manometer/Hydrometer MYR 100/25 0-2,5 bar, 0-25m Wassersäule	
76890110	Wassersackrohr WSU 15 AA AG/AG	

Sonstige Sicherheitsarmaturen

Artikelnummer Bezeichnung

Abbildung

72000000	Anlegethermostat GAT/7 RC 0-90°C flexibler Einstellbereich mit festem Fühler	
----------	---	---

72000001	Tauchthermostat AT 10 / 230V / 0-90°C mit Fernfühler 1m	
72000002	Tauchthermostat GTK//7RD 0-90°C mit Fernfühler 1m	

72006300	Tauchthermostat GTT/7RG 0-90° Tauchhülse 100mm mit Außenskala	
72006400	Tauchthermostat GTT/7RG 0-90° Tauchhülse 200mm mit Außenskala	
72006500	Doppel Tauchthermostat GDT/8RR 0-90°/ 30-120° Tauchhülse 10cm	

76492200	Überströmventil USVR 16-3/4"	
76492400	Überströmventil USVR 20-3/4"	
76492600	Überströmventil USVR 25-1"	
76492800	Überströmventil USVR 25-1 1/4"	
76497200	Meibes Überströmset 3/4 AA 125mm m.Sichtanz	

76880000	KFE Kugelhahn 1/2 vern KFE15 SD/N	
76880001	KFE Kugelhahn 1/2 vern mit Flügelgriff rot Simplex	
76880002	KFE Kugelhahn 1/2 vern Trinkwasser mit Flügelgriff grün Simplex	

76564505	HK Entleerstopfen R 1/2" vern.	
----------	--------------------------------	---

76528200	Thermische Ablaufsicherung STS 20	
----------	-----------------------------------	---

76630200	Feuerungsregler 3/4 RT 20	
----------	---------------------------	---

72000009	Sicherheitstemperaturbegrenzer LS1 90-110°C Kapillarröhre 1,0m / Fühler d= 6,5x95 mm	
72000020	Sicherheitstemperaturbegrenzer fest eingestellt auf 100°C Kapillarr.1000mm	

72000010	Kesselthermostat universal 0-90°C KTC 100 Kapillarröhre 1,5m / Zubehör beachten	
72000012	Drehknopf mit Skala 0-90° / DK / KTC100 für Kapillarthermostat	
72000013	Zierring m.Befestigungsschrauben ZR /KTC100	

72000011	Tauchhülse TH/KTC100 für Kapillarthermostat	
----------	---	---

Pumpengruppen und Zubehör



Artikelnummer Bezeichnung

Abbildung



71776603	Thermoventil DN25 1 1/4" AG HERZ m.Bypass zur Rücklauftemperaturanhebung bei K-Anlage	
71776604	Thermoventil DN32 1 1/2" AG HERZ m. Bypass zur Rücklauftemperaturanhebung bei K-Anlage	

76410240	Meibes PM-Regler für Frischwasserstation LogoVital	
----------	--	---

76410098	MTR Drei-Wege-Mischer DN 20 3/4"IG komplett mit Mischermotor Kvs 12,0	
76410099	MTR Drei-Wege-Mischer DN 25 1"IG komplett mit Mischermotor Kvs 12,0	

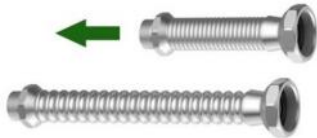
76411004	Meibes Vierwege H Mischer 1"	  
76411003	Meibes Drei-Wege-Mischer 1" 66612	
76411000	Meibes Motor für 3-Wege H/4-Wege H+X Mischer Profiline	
76411002	Adapter für Meibes Mischer m.Meibesaufnahme bis 07/2003	

76446006	Meibes Edelstahl Inoflexi Verbindungsrohr Stretch, 1/2" AG x 3/4" IG, 80mm	
----------	--	---

76450300	Pumpengruppe Profiline UK 1" komplett mit Thermometern/ Isolierung o. Pumpe	
76452310	Pumpengruppe UK 1 ohne Mischer Pumpe Grundfos 25-70/Thermometer/Kugh/Iso	
76452300	Pumpengruppe T-MK 1 1/4 komplett mit Mischer Pumpe/Thermometern/Kugelhähne/Isolierung	
76451300	Pumpengruppe MK 1 komplett mit Mischer Pumpe/Thermometern/Kugelhähne/Isolierung	
76451301	Pumpengruppe Profiline MK 1 ohne Pumpe mit 3-Wege Mischer/Thermom./Kugelh./Isolierung	

76452100	Meibes Rücklauf Absperrset R1 61826	
76453100	Meibes Pumpen Absperrset C1 61822	

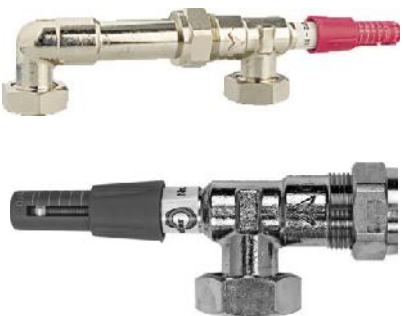
76497200	Meibes Überströmset 3/4 AA 125mm m.Sichtanz	
76907050	Meibes Überströmset - Nachrüstatz für Pumpengruppen UK / MK EDD. 7A	

Ausdehnungsgefäße für Brauchwasser

Artikelnummer Bezeichnung

Abbildung

71710001	Ausdehnungsgefäß 8 Liter durchströmt für Trinkwasser-Anlagen nach DIN 4807-5	
71710012	Ausdehnungsgefäß 12 Liter durchströmt für Trinkwasser-Anlagen nach DIN 4807-5	
71710011	Ausdehnungsgefäß 18 Liter durchströmt für Trinkwasser-Anlagen nach DIN 4807-5	
71710022	Ausdehnungsgefäß 25 Liter durchströmt für Trinkwasser-Anlagen nach DIN 4807-5	
71710032	Ausdehnungsgefäß 33 Liter durchströmt für Trinkwasser-Anlagen nach DIN 4807-5	

71711006	Ausdehnungsgefäß 8 Liter für BW-Anlagen	
71711010	Ausdehnungsgefäß 12 Liter für BW-Anlagen	
71711016	Ausdehnungsgefäß 18 Liter für BW-Anlagen	

71710100	T-Stück für Airfix D 3/4" x 1/2" x 3/4"	
----------	---	---

Ausdehnungsgefäße für Heizungssysteme

Artikelnummer **Bezeichnung**







Abbildung



71720018	Ausdehnungsgefäß 18l für Heizungsanlagen	
71720022	Ausdehnungsgefäß 25l für Heizungsanlagen	
71720032	Ausdehnungsgefäß 35l für Heizungsanlagen	
71720052	Ausdehnungsgefäß 50l für Heizungsanlagen	
71720082	Ausdehnungsgefäß 80l für Heizungsanlagen	
71720102	Ausdehnungsgefäß 100l für Heizungsanlagen	
71720142	Ausdehnungsgefäß 140l für Heizungsanlagen	
71720202	Ausdehnungsgefäß 200l für Heizungsanlagen	
71720302	Ausdehnungsgefäß 300l für Heizungsanlagen	
71720502	Ausdehnungsgefäß 500l für Heizungsanlagen	

Zubehör Gefäße

Artikelnummer Bezeichnung

Abbildung

71712000	Reflex Spannbandset für Gefäße von 8 - 25 Ltr	
76440000	Automatische Schnellkupplung 3/4 MAG	
71715300	Kappenventil 3/4"	
71715400	Kappenventil 1"	
71720900	Gefäßanschlußgruppe	
91167990	Durchströmungsarmatur "Flowjet" zur Absperrung u. Entleerung von durchstr. ADG	
76495200	Thermostatischer BW Mischer TBM 15 1/2	
76495201	Thermostatischer BW Mischer TBM 20/3/4"	
76495300	Thermostatischer BW Mischer MMV-S 20/3/4" geeignet f Solar Heißwasserzufuhr bis 110°C	

4807.20.000	Sicherheitscenter 4807;Sicherheitsgruppe mit Durchströmungsarmatur und MAG 12ltr g.	
00024472	Sicherheitscenter Securfix NG 4807 SV 10bar mit Durchströmungsarmatur und MAG 12 Ltr	
00024572	Sicherheitscenter Securfix NG 4807 SV 10bar mit Durchströmungsarmatur und MAG 18 Ltr	

70572040	Magnesiumanode 3/4 Länge 700 mm MAV 20/700	
70572070	Magnesiumanode MAD 26 / 500 mit Gewindenippel M 8 x 30	
70573210	Magnesiumanode 1 1/4 Länge 400 mm	
70573230	Magnesiumanode 1 1/4 Länge 550 mm	
70592080	Magnesiumanode,Kette mit 5 Gliedern 3/4 Länge 800mm / MAK 20/800	

Heizungsumwälzpumpen und Zubehör

Artikelnummer Bezeichnung





Abbildung



622334204	ProfiLine Fun 40/180 Hocheffizienz-HP BL18 DN 25 1" o.V 4,0mWS	
62235250	WITA HE 35-25 Hoch-Effizienzheizungsp.o.V BL180mm,11/2"AG Energieeffizienzkl. A 4m	
62255251	WITA Delta Midi 60/180 Hoch-Effizienz HP DN 25 11/2"AG o.V. 6,0mWS	
62235320	WITA HE 35-32 Hoch-Effizienzheizungspumpe o.V. BL180mm,2"AG Energieeffizienzkl. A 4m	
71661175	DAB EVOSTA 40-70/130 elektronische HP BL130 DN 15 1" AG o.V 7 mWS	 
71643358	DAB EVOTRON 40/180 Hocheffizienz-HP BL180 DN 25 1" o.V 4,0mWS	
71661177	DAB EVOSTA 40-70/180 elektronische HP BL180 DN 25 1" o.V 4+5+6 mWS	
71643363	DAB EVOTRON 80/180X Hocheffizienz-HP BL180 DN 32 2" o.V 8,0mWS	
71643502	TacoNova ES2ADAPT 60/130 Hocheffizienz-HP BL130 DN 15 1"AG o.V 6,0mWS	 
71643501	TacoNova ES2ADAPT 70/130 Hocheffizienz-HP BL130 DN 15 1"AG o.V 7,0mWS	
71643503	TacoNova ES2ADAPT 60/130 Hocheffizienz-HP BL130 DN 25 11/2"AG o.V 6,0mWS	
71643500	TacoNova ES2ADAPT 60/180 Hocheffizienz-HP BL180 DN 25 11/2"AG o.V 6,0mWS	
71643504	TacoNova ES2ADAPT 60/180 Hocheffizienz-HP BL180 DN 32 2"AG o.V 6,0mWS	

74164031	WiloYonosPico 40/180 Hocheffizienz-HP BL180 DN 25 1" o.V 4,0mWS	
74164032	WiloYonosPico 60/180 Hocheffizienz-HP BL180 DN 25 1" o.V 6,0mWS	
71112560	Umwälzpumpe UPS 25-70 / Baul.130mm 1" geeignet für Solaranlagen	

16510000	Meibes Schwerkraftbremse 1"RV als Einlegeteil passend für Hzg-Verschraubungen	
16510010	Meibes Schwerkraftbremse 3/4"RV als Einlegeteil passend für Hzg-Verschraubungen	
16510020	Meibes Schwerkraftbremse 1 1/4"RV als Einlegeteil passend für Hzg-Verschraubungen	

71220302	Pumpen Verschraubungssatz 1 1/2" x 1" IG (2 Überwürfe, 2 Einlegeteile,)	
71220304	Pumpen Verschraubungssatz 2" x 1 1/4" IG (2 Überwürfe, 2 Einlegeteile,)	

76410300	Pumpenschieber 1	
76408310	Pumpenkugelhahn 1 mit ISO-T Griff Profiline	
76408200	Pumpenkugelhahn 1 1/4 mit ISO-T Griff Profiline	
76408410	Pumpenkugelhahn mit SB 1 mit ISO-T Griff Profiline	
76408500	Pumpenkugelhahn mit SB 1 1/4 mit ISO TGriff Profiline	
76408300	Pumpenkugelhahn 1	
76408400	Pumpenkugelhahn mit SB 1	

3415.00.000	SYR Heizungsfilter HF3415 rückspülbar mit Entschlammungs-u.Magnetabscheidung	
3315.25.000	SYR Heizungs-Kreuzflansch DN 25	
30414614	Heizungsfilter 3/4" mit magnet. Partikel-Abscheider / Magnet im Kernstrom	
30414615	Heizungsfilter 1" mit magnet. Partikel-Abscheider / Magnet im Kernstrom	

30414613	Heizungsfilter Flamco Clean Smart Rp 1" EP drehbar m.magn.Partikel Abscheider	
----------	---	--

Schnellmontagetechnik - Edelstahlwellrohr

Artikelnummer **Bezeichnung**

Abbildung

76455302	Meibes Edelstahlwellrohr 6m Bund DN 16 3/4"	
76455303	Meibes Edelstahlwellrohr 6m Bund DN 20 1"	
76455301	Meibes Edelstahlwellrohr 6m Bund DN 25 1 1/4"	
76455304	Meibes Edelstahlwellrohr 6m Bund DN 32 1 1/2"	
76455312	Meibes Edelstahlwellrohr 50m Bund DN 16 3/4"	

33001619	Edelstahlwellrohr Doppelleitung vorisoliert DN 16 Iso 19mm 50m Bund	
33002019	Edelstahlwellrohr Doppelleitung vorisoliert DN 20 Iso 19mm 50m Bund	
33002519	Edelstahlwellrohr Doppelleitung vorisoliert DN 25 Iso 19mm 15m Bund	

76455402	Meibes Ergänzungssatz 1 St. Einlegering und Dichtung für Wellrohr DN16 /Heizung+Solar	
76455403	Meibes Ergänzungssatz 1 St. Einlegering und Dichtung für Wellrohr DN20 /Heizung+Solar	
76455401	Meibes Ergänzungssatz 1 St. Einlegering und Dichtung für Wellrohr DN25 /Heizung+Solar	
76455404	Meibes Ergänzungssatz 1 St. Einlegering und Dichtung für Wellrohr DN32 /Heizung+Solar	

76455502	Meibes Muttern in MS 58 für Edelstahlwellrohr DN16 3/4" IG	
76455503	Meibes Muttern in MS 58 für Edelstahlwellrohr DN20 1" IG	
76455501	Meibes Muttern in MS 58 für Edelstahlwellrohr DN25 1 1/4" IG	
76455504	Meibes Muttern in MS 58 für Edelstahlwellrohr DN32 1 1/2" IG	

10310050	GMX Füllstutzen 2 AG x DN 50 kurz	
10311050	GMX Füllstutzen 2 AG x DN 50 lang	

10312900	GMX Schutzrohr zur Wanddurchführg. DN50	
----------	---	---

10316040	GMX Winkelbogen DN 40	
10316050	GMX Winkelbogen DN 50	

10344540	GMX ÜG Stk mit IG 2 x DN40 m.Muffe	
10344640	GMX ÜG Stk mit IG 1 1/2 x DN 40 m.Muffe	
10345540	GMX ÜG Stück mit AG 1 1/2 x DN 40 m.Muffe	
10345650	GMX ÜG Stück mit AG 2 x DN 50 m.Muffe	
10373056	GMX ÜG Stück mit AG 2 x DN 50 o.Muffe	
10375055	GMX ÜG Stück mit IG 2 x DN 50 o.Muffe	

10358040	GMX Sicherheitsdunsthut DN 40	
10358050	GMX Sicherheitsdunsthut DN 50	

10379040	GMX Sicherungsschelle DN 40	
10379050	GMX Sicherungsschelle DN 50	
10380040	GMX Dichtelement DN 40	
10380050	GMX Dichtelement DN 50	

10386000 GMX Füllrohrverschluß, MS



10387000 GMX Reißleine komplett



77615512 GOK Membrangesteuerte Hebesicherung f. Öl
bds. R 3/8" IG, einstellbar 0,5-4m



77101900	Grundeinheit Entnahmegarnitur mit Grenzwertgeber bis 2000L (Schlauch 1610 mm) 8mm	
77101974	Entnahme-T-Stück mit Saugschlauch 8mm für PE Tanks einwandig bis 2000L	
77101975	Entnahme-T-Stück mit Saugschlauch 10mm für PE Tanks einwandig, 2500L-4000L	
77101980	Entnahme Dichtring 8mm	
77101981	Entnahme Dichtring 10mm	
77101982	Entnahme Verschlussstopfen 10mm	
77164300	GOK Entnahmearm.für Ölbehälter v.a.Erdtanks mit Rückflußverh.und Messleitung 2150mm	
77164306	GOK Entnahmearmatur für Ölbehälter / 2150mm mit schwimmender Entnahme u. Rückflußverh.	
77164305	GOK Umrüstsatz ohne Messleitung zur schwimmender Entnahme	
77610100	Alu Plastrohr 10 x 1 VPE 50m	
77615096	GOK Ölheberpumpe 2" 1400 mm komplett mit Auslaufschlauch u. Ansaugrohr	
77615097	GOK Ansaugrohr für Ölheberpumpe	
77615098	GOK Auslaufschlauch für Ölheberpumpe	

Abgassysteme

**Fertigschornstein / massiv / Edelstahl einwandig - doppelwandig
auf Anfrage**





FAL

Artikelnummer Bezeichnung

Abbildung

78028060	FAL Bogen 45° DN 60 m.T. gerippt	
78028080	FAL Bogen 45° DN 80 m.T. gerippt	
78028090	FAL Bogen 45° DN 90 m.T. gerippt	
78028100	FAL Bogen 45° DN 100 m.T. gerippt	
78028110	FAL Bogen 45° DN 110 m.T. gerippt	
78028120	FAL Bogen 45° DN 120 m.T. gerippt	
78028130	FAL Bogen 45° DN 130 m.T. gerippt	
78028150	FAL Bogen 45° DN 150 m.T. gerippt	
78028160	FAL Bogen 45° DN 160 m.T. gerippt	

78023060	FAL Bogen 90° DN 60 m.T. gerippt	
78023080	FAL Bogen 90° DN 80 m.T. gerippt	
78023090	FAL Bogen 90° DN 90 m.T. gerippt	
78023100	FAL Bogen 90° DN 100 m.T. gerippt	
78023110	FAL Bogen 90° DN 110 m.T. gerippt	
78023120	FAL Bogen 90° DN 120 m.T. gerippt	
78023130	FAL Bogen 90° DN 130 m.T. gerippt	
78023150	FAL Bogen 90° DN 150 m.T. gerippt	
78023160	FAL Bogen 90° DN 160 m.T. gerippt	

78018100	FAL Segmentbogen DN 100 0-90° mit Tür	
78018110	FAL Segmentbogen DN 110 0-90° mit Tür	
78018120	FAL Segmentbogen DN 120 0-90° mit Tür	
78018130	FAL Segmentbogen DN 130 0-90° mit Tür	
78018150	FAL Segmentbogen DN 150 0-90° mit Tür	
78018160	FAL Segmentbogen DN 160 0-90° mit Tür	
78018180	FAL Segmentbogen DN 180 0-90° mit Tür	

78002060	FAL Rohr DN 60 0,25m	
78002080	FAL Rohr DN 80 0,25m	
78002090	FAL Rohr DN 90 0,25m	
78002100	FAL Rohr DN 100 0,25m	
78002110	FAL Rohr DN 110 0,25m	
78002120	FAL Rohr DN 120 0,25m	
78002130	FAL Rohr DN 130 0,25m	
78002150	FAL Rohr DN 150 0,25m	
78002160	FAL Rohr DN 160 0,25m	
78002180	FAL Rohr DN 180 0,25m	

78001060	FAL Rohr DN 60 0,5m	
78001080	FAL Rohr DN 80 0,5m	
78001090	FAL Rohr DN 90 0,5m	
78001100	FAL Rohr DN 100 0,5m	
78001110	FAL Rohr DN 110 0,5m	
78001120	FAL Rohr DN 120 0,5m	
78001130	FAL Rohr DN 130 0,5m	
78001150	FAL Rohr DN 150 0,5m	
78001160	FAL Rohr DN 160 0,5m	
78001180	FAL Rohr DN 180 0,5m	

78000060	FAL Rohr DN 60 1,0m	
78000080	FAL Rohr DN 80 1,0m	
78000090	FAL Rohr DN 90 1,0m	
78000100	FAL Rohr DN 100 1,0m	
78000110	FAL Rohr DN 110 1,0m	
78000120	FAL Rohr DN 120 1,0m	
78000130	FAL Rohr DN 130 1,0m	
78000150	FAL Rohr DN 150 1,0m	
78000160	FAL Rohr DN 160 1,0m	
78000180	FAL Rohr DN 180 1,0m	

78030060	FAL Wandfutter doppelt DN 60	
78030080	FAL Wandfutter doppelt DN 80	
78030090	FAL Wandfutter doppelt DN 90	
78030100	FAL Wandfutter doppelt DN 100	
78030110	FAL Wandfutter doppelt DN 110	
78030120	FAL Wandfutter doppelt DN 120	
78030130	FAL Wandfutter doppelt DN 130	
78030150	FAL Wandfutter doppelt DN 150	
78030160	FAL Wandfutter doppelt DN 160	

78037060	FAL Kappe DN 60	
78037080	FAL Kappe DN 80	
78037090	FAL Kappe DN 90	
78037100	FAL Kappe DN 100	
78037110	FAL Kappe DN 110	
78037120	FAL Kappe DN 120	
78037130	FAL Kappe DN 130	
78037150	FAL Kappe DN 150	

78003110	FAL Wandrosette DN 110 - 135	
78003140	FAL Wandrosette DN 140 - 160	
78003180	FAL Wandrosette DN 180 - 200	

78061000	FAL Reduzierstück DN 110/100	
78061009	FAL Reduzierstück DN 110/ 90	
78061012	FAL Reduzierstück DN 100/120	
78062010	FAL Reduzierstück DN 120/100	
78062011	FAL Reduzierstück DN 120/110	
78062080	FAL Reduzierstück DN 200/180 0,8 mm	
78063008	FAL Reduzierstück DN 130/ 80	
78063009	FAL Reduzierstück DN 130/ 90	
78063013	FAL Reduzierstück DN 130/113	
78063020	FAL Reduzierstück DN 130/120	
78063050	FAL Reduzierstück DN 130/150	
78065020	FAL Reduzierstück DN 150/120	
78065030	FAL Reduzierstück DN 150/130	
78066050	FAL Reduzierstück DN 160/150	
78068030	FAL Reduzierstück DN 180außen / 130 innen	
78068050	FAL Reduzierstück DN 180/150	
78068060	FAL Reduzierstück DN 180/160	



Rauchrohr

78081130	Rauchrohr 2,0mm DN 130 x 0,25m Stahlblech schwarz	
78081150	Rauchrohr 2,0mm DN 150 x 0,25m Stahlblech schwarz	
78081160	Rauchrohr 2,0mm DN 160 x 0,25m Stahlblech schwarz	
78081180	Rauchrohr 2,0mm DN 180 x 0,25m Stahlblech schwarz	
78081200	Rauchrohr 2,0mm DN 200 x 0,25m Stahlblech schwarz	

78082130	Rauchrohr 2,0mm DN 130 x 0,5m Stahlblech schwarz	
78082150	Rauchrohr 2,0mm DN 150 x 0,5m Stahlblech schwarz	
78082160	Rauchrohr 2,0mm DN 160 x 0,5m Stahlblech schwarz	
78082180	Rauchrohr 2,0mm DN 180 x 0,5m Stahlblech schwarz	
78082200	Rauchrohr 2,0mm DN 200 x 0,5m Stahlblech schwarz	

78083130	Rauchrohr 2,0mm DN 130 x 1,0m Stahlblech schwarz	
78083150	Rauchrohr 2,0mm DN 150 x 1,0m Stahlblech schwarz	
78083160	Rauchrohr 2,0mm DN 160 x 1,0m Stahlblech schwarz	
78083180	Rauchrohr 2,0mm DN 180 x 1,0m Stahlblech schwarz	
78083200	Rauchrohr 2,0mm DN 200 x 1,0m Stahlblech schwarz	

78087130	Rauchrohr Bogen DN 130 m.Tür Stahlblech schwarz 2,0mm drehbar 0-90°	
78087150	Rauchrohr Bogen DN 150 m.Tür Stahlblech schwarz 2,0mm drehbar 0-90°	
78087160	Rauchrohr Bogen DN 160 m.Tür Stahlblech schwarz 2,0mm drehbar 0-90°	
78087180	Rauchrohr Bogen DN 180 m.Tür Stahlblech schwarz 2,0mm drehbar 0-90°	
78087200	Rauchrohr Bogen DN 200 m.Tür Stahlblech schwarz 2,0mm drehbar 0-90°	

78088130	Rauchrohr Wandfutter DN 130 einfach 0,6mm	
78088150	Rauchrohr Wandfutter DN 150 einfach 0,6mm	
78088160	Rauchrohr Wandfutter DN 160 einfach 0,6mm	
78088180	Rauchrohr Wandfutter DN 180 einfach 0,6mm	
78088200	Rauchrohr Wandfutter DN 200 einfach 0,6mm	
78880131	Rauchrohr Wandfutter DN130 doppelt	
78088151	Rauchrohr Wandfutter DN 150 doppelt	
78088161	Rauchrohr Wandfutter DN 160 doppelt	
78088201	Rauchrohr Wandfutter DN 200 doppelt	

78089150	Rauchrohr Red-Stück 150 weit /130 eng 2,0mm Stahlblech schwarz		
78089160	Rauchrohr Red-Stück 160 weit /150 eng 2,0mm Stahlblech schwarz		
78089161	Rauchrohr Red-Stück 160 eng /130 weit 2,0mm Stahlblech schwarz		
78089162	Rauchrohr Red-Stück 160 weit /130 eng 2,0mm Stahlblech schwarz		
78089180	Rauchrohr Red-Stück 180 weit /150 eng 2,0mm Stahlblech schwarz		
78089181	Rauchrohr Red-Stück 180 eng /130 weit 2,0mm Stahlblech schwarz		
78089182	Rauchrohr Red-Stück 180 eng /160 weit 2,0mm Stahlblech schwarz		
78089183	Rauchrohr Red-Stück 180 weit /130 eng 2,0mm Stahlblech schwarz		
78089184	Rauchrohr Red-Stück 180 weit /160 eng 2,0mm Stahlblech schwarz		
78089200	Rauchrohr Red-Stück 200 weit /180 eng 2,0mm Stahlblech schwarz		
78089201	Rauchrohr Red-Stück 200 weit /150 eng 2,0mm Stahlblech schwarz		
78089202	Rauchrohr Red-Stück 200 eng /160 weit 2,0mm Stahlblech schwarz		
78089203	Rauchrohr Red-Stück 200 weit /160 eng 2,0mm Stahlblech schwarz		

Univeral PHK - 6 Muffen

PHK Typ 10 / 11 - PLAN PHK - auf Anfrage nicht aufgeführte Größen - auf Anfrage

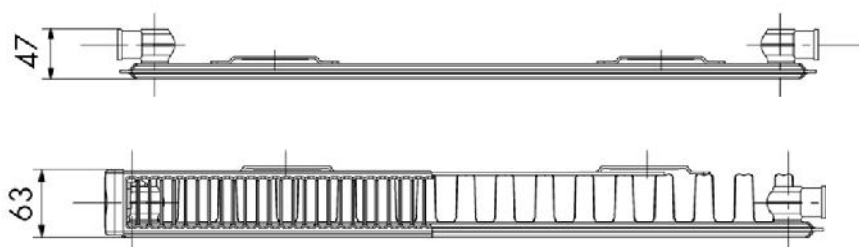

Artikelnummer Bezeichnung
Typ 21

Abbildung

86521504	Universal PHK Typ 21 500/ 400 bei 70°/55° VLT = 360W	<p>66mm</p>
86521505	Universal PHK Typ 21 500/ 500 bei 70°/55° VLT = 450 W	
86521506	Universal PHK Typ 21 500/ 600 bei 70°/55° VLT = 540 W	
86521507	Universal PHK Typ 21 500/ 700 bei 70°/55° VLT= 630 W	
86521508	Universal PHK Typ 21 500/ 800 bei 70°/55° VLT = 720 W	
86521604	Universal PHK Typ 21 600/ 400 bei 70°/55° VLT = 415 W	
86521605	Universal PHK Typ 21 600/ 500 bei 70°/55° VLT = 519 W	
86521606	Universal PHK Typ 21 600/ 600 bei 70°/55° VLT = 622 W	
86521608	Universal PHK Typ 21 600/ 800 bei 70°/55° VLT= 830 W	
86521610	Universal PHK Typ 21 600/ 1000 bei 70°/55° VLT = 1037 W	

Typ 22

87022306	Universal PHK Typ 22 300/ 600 bei 70°/55° VLT = 467 W
87022308	Universal PHK Typ 22 300/ 800 bei 70°/55° VLT = 623 W
87022310	Universal PHK Typ 22 300/ 1000 bei 70°/55° VLT = 778 W
87022312	Universal PHK Typ 22 300/ 1200 bei 70°/55° VLT = 934 W
87022314	Universal PHK Typ 22 300/ 1400 bei 70°/55° VLT = 1090 W
87022315	Universal PHK Typ 22 300/ 1600 bei 70°/55° VLT = 1245 W
87022318	Universal PHK Typ 22 300/ 1800 bei 70°/55° VLT = 1401 W
86522406	Universal PHK Typ 22 400/ 600 bei 70°/55° VLT = 588 W
86522407	Universal PHK Typ 22 400/ 700 bei 70°/55° VLT = 686 W
86522408	Universal PHK Typ 22 400/ 800 bei 70°/55° VLT = 783 W
86522410	Universal PHK Typ 22 400/ 1000 bei 70°/55° VLT = 979 W
86522412	Universal PHK Typ 22 400/ 1200 bei 70°/55° VLT = 1175 W
86522414	Universal PHK Typ 22 400/ 1400 bei 70°/55° VLT = 1371 W
86522416	Universal PHK Typ 22 400/ 1600 bei 70°/55° VLT = 1567 W

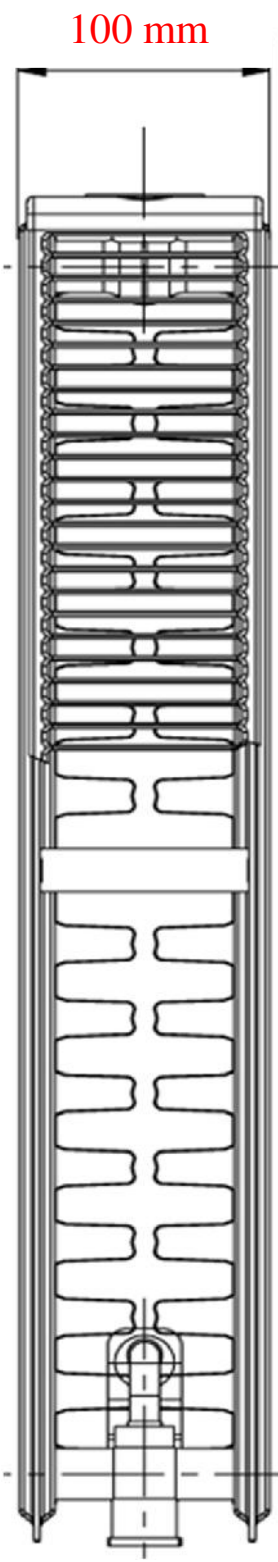

The technical drawing on the right shows a vertical radiator with a width of 100 mm. It features a series of horizontal fins and a central vertical pipe. The drawing is a cross-section showing the internal structure of the radiator, including the heating elements and the flow channels. The width of the radiator is indicated by a dimension line at the top, labeled '100 mm' in red text.

87022504	Universal PHK Typ 22 500/ 500 bei 70°/55° VLT = 585 W
87022506	Universal PHK Typ 22 500/ 600 bei 70°/55° VLT = 701 W
86522507	Universal PHK Typ 22 500/ 700 bei 70°/55° VLT = 818 W
87022508	Universal PHK Typ 22 500/ 800 bei 70°/55° VLT = 935 W
86522509	Universal PHK Typ 22 500/ 900 bei 70°/55° = 1052 W
87022510	Universal PHK Typ 22 500/ 1000 bei 70°/55° VLT = 1169 W
87022512	Universal PHK Typ 22 500/ 1200 bei 70°/55° VLT = 1403 W
87022514	Universal PHK Typ 22 500/ 1400 bei 70°/55° VLT = 1637 W
87022515	Universal PHK Typ 22 500/ 1600 bei 70°/55° VLT = 1871 W
87022518	Universal PHK Typ 22 500/ 1800 bei 70°/55° VLT = 2104 W
87022520	Universal PHK Typ 22 500/ 2000 bei 70°/55° VLT = 2338 W
86522523	Universal PHK Typ 22 500/ 2300 bei 70°/55° VLT = 2689 W

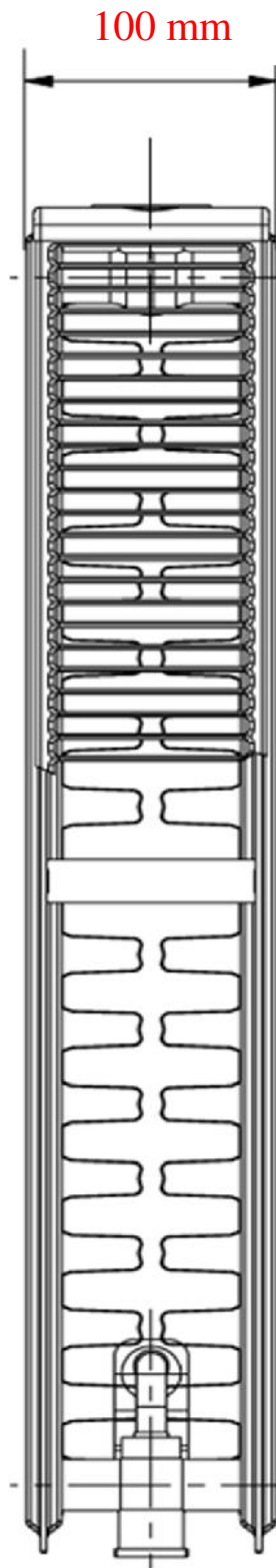

87022604	Universal PHK Typ 22 600/ 500 bei 70°/55° VLT = 676 W
87022606	Universal PHK Typ 22 600/ 600 bei 70°/55° VLT = 811 W
86522607	Universal PHK Typ 22 600/ 700 bei 70°/55° VLT = 946 W
87022608	Universal PHK Typ 22 600/ 800 bei 70°/55° VLT = 1081 W
86522609	Universal PHK Typ 22 600/ 900 bei 70°/55° VLT = 1216 W
87022610	Universal PHK Typ 22 600/ 1000 bei 70°/55° VLT = 1351 W
87022612	Universal PHK Typ 22 600/ 1200 bei 70°/55° VLT = 1622 W
87022614	Universal PHK Typ 22 600/ 1400 bei 70°/55° VLT = 1892 W
87022615	Universal PHK Typ 22 600/ 1600 bei 70°/55° VLT = 2162 W
87022618	Universal PHK Typ 22 600/ 1800 bei 70°/55° VLT = 2433 W
87022620	Universal PHK Typ 22 600/ 2000 bei 70°/55° VLT = 2703 W
86522622	Universal PHK Typ 22 600/ 2300 bei 70°/55° VLT = 3108 W

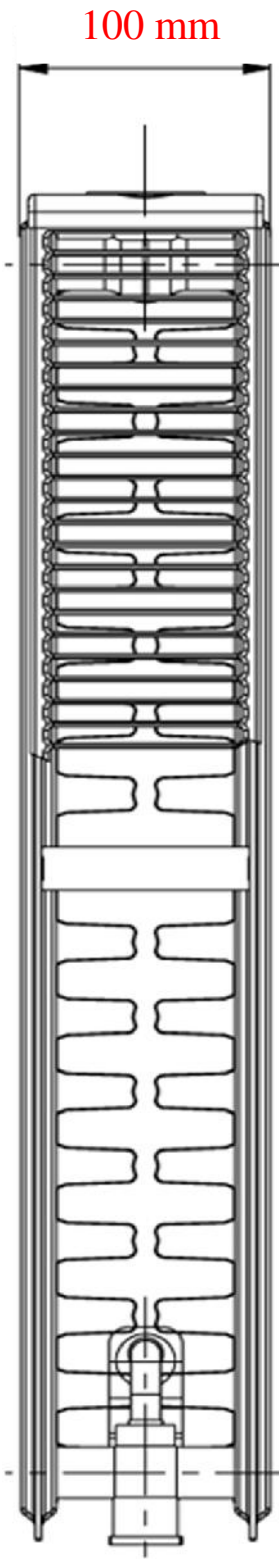

87022903	Universal PHK Typ 22 900/ 400 bei 70°/55° VLT = 742 W	
87022904	Universal PHK Typ 22 900/ 500 bei 70°/55° VLT = 928 W	
87022906	Universal PHK Typ 22 900/ 600 bei 70°/55° VLT = 1113 W	
87022917	Universal PHK Typ 22 900/ 700 bei 70°/55° VLT = 1299 W	
87022908	Universal PHK Typ 22 900/ 800 bei 70°/55° VLT = 1484 W	
86522909	Universal PHK Typ 22 900/ 900 bei 70°/55° VLT = 1670 W	

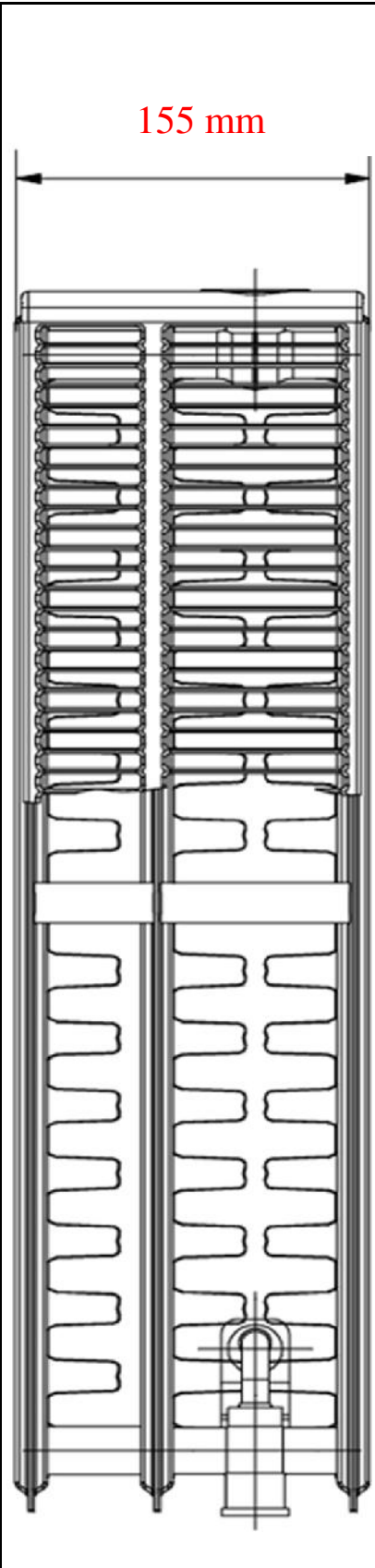

Typ 33

87033308	Universal PHK Typ 33 300/ 800 bei 70°/55° VLT = 893 W	 <p>155 mm</p>
87033310	Universal PHK Typ 33 300/ 1000 bei 70°/55° VLT = 1117 W	
87033312	Universal PHK Typ 33 300/ 1200 bei 70°/55° VLT = 1340 W	
87033314	Universal PHK Typ 33 300/ 1400 bei 70°/55° VLT = 1564 W	
86533504	Universal PHK Typ 33 500/ 400 bei 70°/55° VLT = 670 W	
86533505	Universal PHK Typ 33 500/ 500 bei 70°/55° VLT = 838 W	
86533506	Universal PHK Typ 33 500/ 600 bei 70°/55° VLT = 1005 W	
86533507	Universal PHK Typ 33 500/ 700 bei 70°/55° VLT = 1173 W	
87033508	Universal PHK Typ 33 500/ 800 bei 70°/55° VLT = 1340 W	
86533509	Universal PHK Typ 33 500/ 900 bei 70°/55° VLT = 1508 W	
87033510	Universal PHK Typ 33 500/ 1000 bei 70°/55° VLT = 1675 W	
87033512	Universal PHK Typ 33 500/ 1200 bei 70°/55° VLT = 2010 W	
87033514	Universal PHK Typ 33 500/ 1400 bei 70°/55° VLT = 2346 W	

86533604	Universal PHK Typ 33 600/ 400 bei 70°/55° VLT = 774 W	
87033604	Universal PHK Typ 33 600/ 500 bei 70°/55° VLT = 967 W	
87033606	Universal PHK Typ 33 600/ 600 bei 70°/55° VLT = 1160 W	
86533607	Universal PHK Typ 33 600/ 700 bei 70°/55° VLT = 1354 W	
87033608	Universal PHK Typ 33 600/ 800 bei 70°/55° VLT = 1547 W	
86533609	Universal PHK Typ 33 600/ 900 bei 70°/55° VLT = 1741 W	
87033610	Universal PHK Typ 33 600/ 1000 bei 70°/55° VLT = 1934 W	
87033612	Universal PHK Typ 33 600/ 1200 bei 70°/55° VLT = 2321 W	
87033614	Universal PHK Typ 33 600/ 1400 bei 70°/55° VLT = 2708 W	
87033615	Universal PHK Typ 33 600/ 1600 bei 70°/55° VLT = 3095 W	
87033906	Universal PHK Typ 33 900/ 600 bei 70°/55° VLT = 1600 W	

Bad - Heizkörper

Artikelnummer Bezeichnung

Abbildung

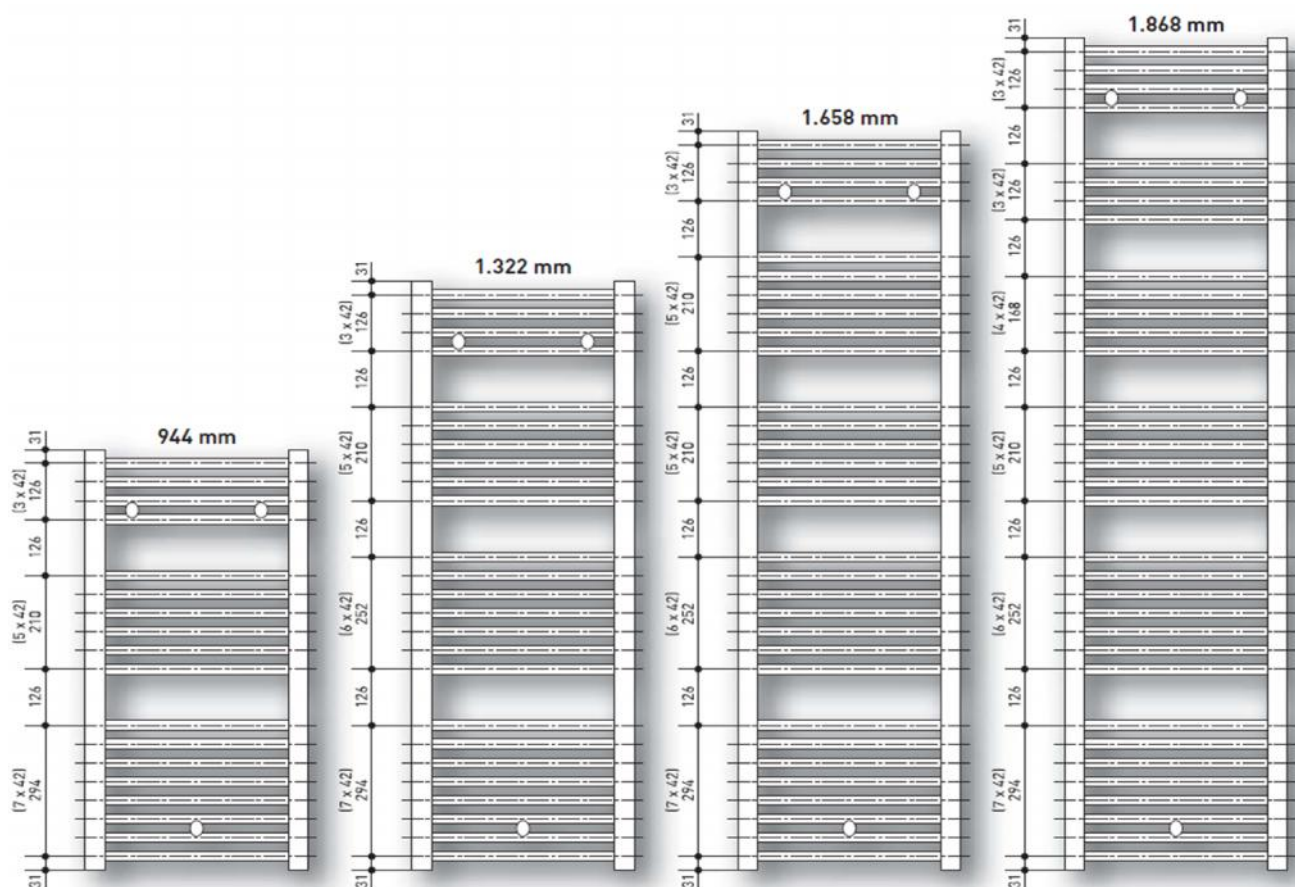

88260945	Badheizkörper Evelino 944 x 450 RAL9016 Watt bei 70/55/20° =331
88260950	Badheizkörper Evelino 944 x 500 RAL9016 Watt bei 70/55/20°=361
88260960	Badheizkörper Evelino 944 x 600 RAL9016 Watt bei 70/55/20° =421
88260975	Badheizkörper Evelino 944 x 750 RAL9016 Watt bei 70/55/20° =510



88261345	Badheizkörper Evelino 1322 x 450 RAL9016 Watt bei 70/55/20° =453
88261350	Badheizkörper Evelino 1322 x 500 RAL9016 Watt bei 70/55/20° =495
88261360	Badheizkörper Evelino 1322 x 600 RAL9016 Watt bei 70/55/20° =576
88261375	Badheizkörper Evelino 1322 x 750 RAL9016 Watt bei 70/55/20° =700
88261645	Badheizkörper Evelino 1658 x 450 RAL9016 Watt bei 70/55/20° =558
88261650	Badheizkörper Evelino 1658 x 500 RAL9016 Watt bei 70/55/20°=610
88261660	Badheizkörper Evelino 1658 x 600 RAL9016 Watt bei 70/55/20° =714
88261675	Badheizkörper Evelino 1658 x 750 RAL9016 Watt bei 70/55/20° =870
88261845	Badheizkörper Evelino 1868 x 450 RAL9016 Watt bei 70/55/20° =625
88261850	Badheizkörper Evelino 1868 x 500 RAL9016 Watt bei 70/55/20°=683
88261860	Badheizkörper Evelino 1868 x 600 RAL9016 Watt bei 70/55/20° =800
88261875	Badheizkörper Evelino 1868 x 750 RAL9016 Watt bei 70/55/20° =976



88270945	Badheizkörper Evelino 944 x 450 RAL9016 Mittelanschluss Watt bei 70/55/20° 331
88270950	Badheizkörper Evelino 944 x 500 RAL9016 Mittelanschluss Watt bei 710/55/20°361
88270960	Badheizkörper Evelino 944 x 600 RAL9016 Mittelanschluss Watt bei 70/55/20° 421
88270975	Badheizkörper Evelino 944 x 750 RAL9016 Mittelanschluss Watt bei 70/55/20° 510
88271345	Badheizkörper Evelino 1322 x 450 RAL9016 Mittelanschluss Watt bei 70/55/20° 453
88271350	Badheizkörper Evelino 1322 x 500 RAL9016 Mittelanschluss Watt bei 70/55/20°495
88271360	Badheizkörper Evelino 1322 x 600 RAL9016 Mittelanschluss Watt bei 70/55/20° 576
88271375	Badheizkörper Evelino 1322 x 750 RAL9016 Mittelanschluss Watt bei 70/55/20° 700
88271645	Badheizkörper Evelino 1658 x 450 RAL9016 Mittelanschluss Watt bei 70/55/20° 558
88271650	Badheizkörper Evelino 1658 x 500 RAL9016 Mittelanschluss Watt bei 70/55/20°610
88271660	Badheizkörper Evelino 1658 x 600 RAL9016 Mittelanschluss Watt bei 70/55/20° 714
88271675	Badheizkörper Evelino 1658 x 750 RAL9016 Mittelanschluss Watt bei 70/55/20° 870



88271845	Badheizkörper Evelino 1868 x 450 RAL9016 Mittelanschluss Watt bei 70/55/20° 625	
88271850	Badheizkörper Evelino 1868 x 500 RAL9016 Mittelanschluss Watt bei 70/55/20° 683	
88271860	Badheizkörper Evelino 1868 x 600 RAL9016 Mittelanschluss Watt bei 70/55/20° 800	
88271875	Badheizkörper Evelino 1868 x 750 RAL9016 Mittelanschluss Watt bei 70/55/20° 976	

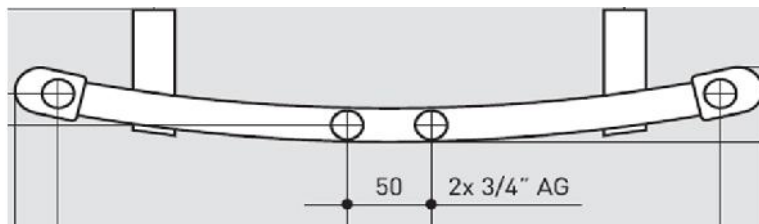

99271650	Badheizkörper Evelino 1658x495 gebogen Mittelanschluss, weiß, Watt 70/55/20°=610	
99271660	Badheizkörper Evelino 1658 x 593 gebogen Mittelanschluss weiß Watt bei 70/55/20° 714	

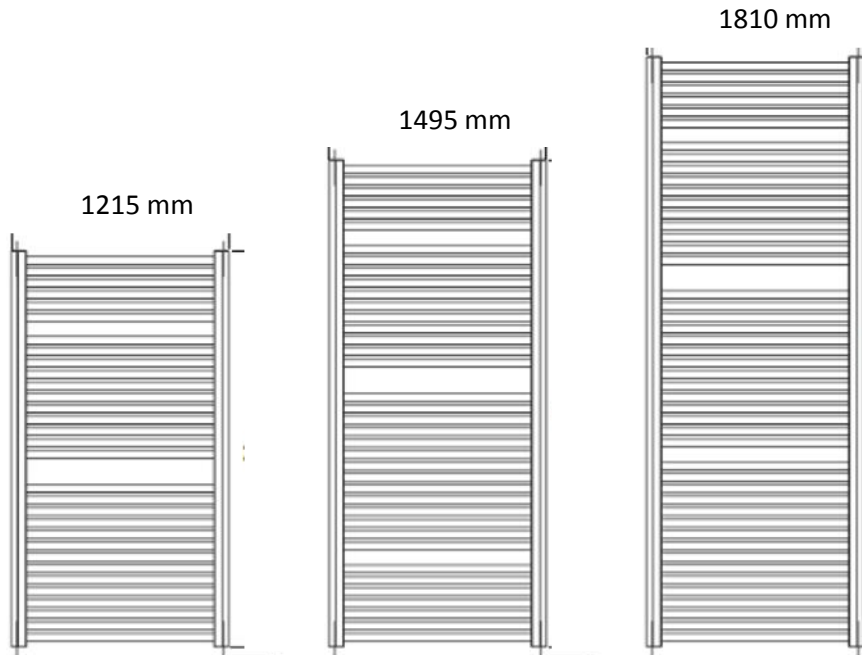



88261259	Badheizkörper LinearMax 1200 x 600 RAL9016 Watt bei 70/55/20° =635
88261275	Badheizkörper LinearMax 1200 x 750 RAL9016 Watt bei 70/55/20° =795
88261445	Badheizkörper LinearMax 1500 x 450 RAL9016 Watt bei 70/55/20° = 520
88261459	Badheizkörper LinearMax 1500 x 600 RAL9016 Watt bei 70/55/20° =788
88261475	Badheizkörper LinearMax 1500 x 750 RAL9016 Watt bei 70/55/20° =985
88261846	Badheizkörper LinearMax 1800 x 450 RAL9016 Watt bei 70/55/20° =671
88261861	Badheizkörper LinearMax 1800 x 600 RAL9016 Watt bei 70/55/20° =969
88261870	Badheizkörper LinearMax 1800 x 750 RAL9016 Watt bei 70/55/20° =1214

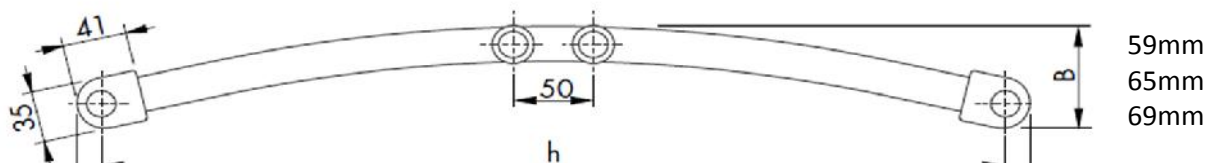

88271260	Badheizkörper LinearMax 1200 x 600 RAL9016 Mittelanschluss Watt bei 70/55/20° 593	
88271275	Badheizkörper LinearMax 1200 x 750 RAL9016 Mittelanschluss Watt bei 70/55/20° 735	
88271560	Badheizkörper LinearMax 1500 x 600 RAL9016 Mittelanschluss Watt bei 70/55/20° 731	
88271575	Badheizkörper LinearMax 1500 x 750 RAL9016 Mittelanschluss Watt bei 70/55/20° 908	
88271861	Badheizkörper LinearMax 1800 x 600 RAL9016 Mittelanschluss Watt bei 70/55/20° 889	
88271870	Badheizkörper LinearMax 1800 x 750 RAL9016 Mittelanschluss Watt bei 70/55/20° 1107	





99271260	Badheizkörper RondoMax 1200 x 600 gebogen Mittelanschluss weiß Watt bei 70/55/20° 632	
99271560	Badheizkörper RondoMax 1500 x 600 gebogen Mittelanschluss weiß Watt bei 70/55/20° 780	
99271861	Badheizkörper RondoMax 1800 x 600 gebogen Mittelanschluss weiß Watt bei 70/55/20° 946	

88169500	Elektro-Heizstab 400 Watt mit Kabel, ohne Schalter	
88169510	Elektro-Heizstab 600 Watt mit Kabel, ohne Schalter	
88169520	Elektro-Heizstab 800 Watt mit Kabel, ohne Schalter	

88260030	Handtuchhalterknopf für Bad-HK Evelino RAL 9016	
----------	--	---

88260040	Handtuchhalter für Bad-HK Evelino 400mm RAL 9016	
88260050	Handtuchhalter für Bad-HK Evelino 500mm RAL 9016	
88260060	Handtuchhalter für Bad-HK Evelino 600mm RAL 9016	

88260041	Handtuchhalter für Bad-HK Koralux 370mm	
88260051	Handtuchhalter für Bad-HK Koralux 518mm	

88260010	Befestigungssatz für Bad-HK Evelino gerade	
88260020	Befestigungssatz für Bad-HK Koralux gerade und gebogen	

HK - Befestigung

Artikelnummer Bezeichnung

Abbildung

87937103	Kompaktset FC 30	
87937104	Kompaktset FC 40	
87937105	Kompaktset FC 50	
87937106	Kompaktset FC 60	
87937109	Kompaktset FC 90	

87937000	Winkellaschenset WS	 2x
----------	---------------------	--

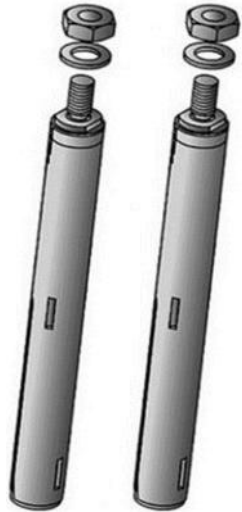

87940005	Standkonsole SK-U universal komplett mit Standrohr	
87940020	HK Kunststoffrosette KFF weiß f. SK-U	

87936100	HK Bohrkonsole PSE 100x18 RHG mit M8 Gewinde	
87936130	HK Bohrkonsole PSE 130x18 RHG mit M8 Gewinde	
87936160	HK Bohrkonsole PSE 160x18 RHG mit M8 Gewinde	
87936200	HK Bohrkonsole PSE 200x18 RHG mit M8 Gewinde	
87936240	HK Bohrkonsole PSE 240x18 RHG mit M8 Gewinde	

87934160	HK Bohrkonsole PSE 160x18 RHE	
87934130	HK Bohrkonsole PSE 130x18 RHE	

87935160	HK Bohrset FBL 160	
87935200	HK Bohrset FBL 200	



87936999	HK Abstandhalter zum Aufkleben 596 tiefenverstellbar f.HK mit Laschen	
----------	--	---



87941000	Halter für Radiatoren 569 / einzeln	
87942000	Universal Wandkonsole für Radiatoren 567 einzeln	

HK - Ventile und Zubehör



Artikelnummer **Bezeichnung**

Abbildung

84420000	Comap HK Ventil 3/8 Eck f.IF1 D 804 M30 x 1,5	
84420100	Comap HK Ventil 1/2 Eck f.IF1 D 804 M30 x 1,5	
84420200	Comap HK Ventil 3/4 Eck f.IF1 D 804 M30 x 1,5	
84421000	Comap HK Ventil 3/8 D f.IF1 D 805 M30 x 1,5	
84421100	Comap HK Ventil 1/2 D f.IF1 D 805 M30 x 1,5	
84421200	Comap HK Ventil 3/4 D f.IF1 D 805 M30 x 1,5	
84422010	Comap HK Ventil 1/2 axial f.IF1 D 908 M30 x 1,5	
84423100	Comap HK Ventil 1/2 Thermotr f.IF1 D 933 Links/Rechtseinbau Kv 0,64 M30 x 1,5	
84421300	Herz HK Ventil 1" D M28	
84421101	Heimeier HK Ventil 1/2 Dg für umgekehrte Flußrichtung	
84420101	Heimeier HK Ventil 1/2 Eck für umgekehrte Flußrichtung	









84419000	Herz Tauchrohr-Thermostatventil 1/2" Eck für Einrohrsystem	
84419001	Herz Tauchrohr-Thermostatventil 1/2" Eck für Zweirohrsystem	
84419002	Herz Tauchrohr-Thermostatventil 1/2" Dg für Einrohrsystem	
84419003	Herz Tauchrohr-Thermostatventil 1/2" Dg für Zweirohrsystem	
84400445	Comap Tauchrohr-Thermostatventil für Einrohrsystem. 1/2" D445 Eurok.Anschl.unten	

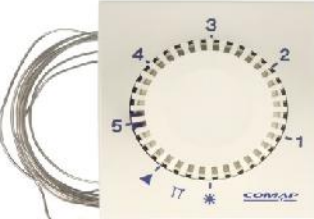

87000000	Ventileinsatz für Universal PHK 1/2"	
----------	--------------------------------------	---

85237141	Rosswainer 3-Wege-Thermost.-Ventilunterteil 752.6K DN 15 o.Voreins.,rechts.Anbindg,Bypaß	 
85237151	Rosswainer 3-Wege-Thermost.-Ventilunterteil 752.7K DN 15 o.Voreinst.,linkss.Anbindg,Bypaß	
85200000	Rosswainer Verschraubungssatz für Dreiwegeventile für Forsterheizung	
85232001	Rosswainer Bypass T-Stück DN 15 Art.-Nr.780 für Forsterheizung	
85351241	Rosswainer Bypassrohr DN15x600,vern. 766	









17761380	Dreiwege-Umschaltventil DN15 3/4" AG M28 flach dichtend, ohne Verschraubung	
17761390	Dreiwege-Umschaltventil DN20 1" AG M28 flach dichtend, ohne Verschraubung	
17761400	Dreiwege-Umschaltventil DN25 1 1/4" AG M28 flach dichtend, ohne Verschraubung	
17761410	Dreiwege-Umschaltventil DN32 1 1/2" AG M28 flach dichtend, ohne Verschraubung	





84440020	Comap Thermostatkopf IF 1 M30 x 1,5	
84440025	Comap Thermostatkopf Senso Schnappverschluß für Danfossventilunterteile	
85352310	Rosswainer Thermostatkopf Art.-Nr.74.15 o.Nullstellung M 33 x 2	
84920030	Herz Thermostatkopf Mini M28x1,5	
84920068	Herz Thermostatkopf Mini M30x1,5	
84440040	Oventrop Thermostatkopf M 30 x 1,0	

84441020	Comap Thermostatkopf FF1 m Fernfühler 2m	
84441102	Comap Thermostatkopf m Fernversteller 2m für IF-Ventile M 30	
84441105	Comap Thermostatkopf m Fernversteller 5m für IF-Ventile M 30	
84441108	Comap Thermostatkopf m Fernversteller 8m für IF-Ventile M 30	
81942088	Herz Thermostatkopf M30x1,5 m.Anlegefühler Kappilarrohr 2m 20-50°C für FB-Heizung	
84474200	Herz Thermostatkopf M28x1,5 m.Anlegefühler Kappilarrohr 2m 20-50°C für FB-Heizung	
84474210	Herz Thermostatkopf M28x1,5 m.Anlegefühler Kappilarrohr 2m 40-70°C für FB-Heizung	
84442010	Comap Thermostatkopf FF1 STD 2m M30x1,5 mit Tauchfühler 25°C - 70 °C	



84412016	HK Ventil Vorlauf uni. Dg/Eck 1/2 / weiß für Bad HK mit MA / inkl.Thermostatkopf	
84412017	HK Ventil Vorlauf uni. Dg/Eck 1/2 / vc für Bad HK mit MA / inkl.Thermostatkopf	

84744015	HK Verschraubung 15x1/2 Eck, vernickelt	
84745015	HK Verschraubung 15x1/2 D, vernickelt	
84746120	HK Verschraubung 15 Press x 1/2 Eck , blank	
84745125	HK Verschraubung 15 Press x 1/2 D, blank	
84746000	HK Verschraubung 3/8" Eck vernickelt	
84746100	HK Verschraubung 1/2 Eck, vernickelt	
84746200	HK Verschraubung 3/4 Eck, vernickelt	
84747000	HK Verschraubung 3/8" D vernickelt	
84747100	HK Verschraubung 1/2 D, vernickelt	
84747200	HK Verschraubung 3/4 D, vernickelt	





88001010	Zweirohr Hahnblock Eck 1/2" AG x Eurok.	
88001012	Zweirohr Hahnblock Dg 1/2" AG x Eurok.	
88002010	Zweirohr-Hahnblock Eck 3/4" IG x Eurok. für HK mit 3/4" AG	
88002012	Zweirohr-Hahnblock Dg 3/4" IG x Eurok. für HK mit 3/4" AG	
88001003	Bypaß Hahnblock winkl. BAW 1/2" AG Eck	
88001005	Bypaß Hahnblock BAV 1/2" AG Durchgang	
88003010	Hahnblock - universal VarioCon N1 Eck-und DG Ansl. m. AN-Nip. 1/2" AG	
88003020	Hahnblock - universal m.Bypass VarioCon U1 Eck-und DG Ansl. m. AN-Nip. 1/2" AG	

88001030	Umlenkstück Dg 2/50 absperrbar für vertauschten Vor-und Rücklauf	
88001040	Umlenkstück Eck 2/50 absperrbar für vertauschten Vor-und Rücklauf	
13004340	HERZ Umlenkstück Dg 2/50 nicht absperrbar für vertauschten Vor-und Rücklauf	
13404340	HERZ Umlenkstück Dg 2/50 absperrbar für vertauschten Vor-und Rücklauf	
88010093	Hahnblock Verkleidung Durchgang Kunststoff weiß	
88010094	Hahnblock Verkleidung Eck Kunststoff weiß	

88007117	Euro-Einlegekonus Kst. für Hahnblock 3/4"	
88010041	Bauschutzkappe für Hahnblockanschluss für 12-16mm Rohr, wiederverwendbar	
88010088	Hahnblock Prüf-u.Abdrückbrücke mit Luftstopfen für Rohr 15mm	
87901563	HK Abdrückbogen vern.3/4" zum Verschluss von HK - Hahnblöcken	

88001020	HK-Verschr. AVD R1/2 Eurok.3/4" Dg flach	
88001021	HK-Verschr. AVW R1/2 Eurok.3/4" E flach	



88001187	Klemmset CU vn A1-10-2 10x1mm / 2-fach Eurokonus	
88001188	Klemmset CU vn F11-12-2 12x1mm / 2-fach Eurokonus	
88001189	Klemmset CU vn F11-14-2 14x1mm / 2-fach Eurokonus	
88001190	Klemmset CU vn F11-15-2 15x1mm / 2-fach Eurokonus	
88001191	Klemmset CU vn F11-16-2 16x1mm / 2-fach Eurokonus	
88001192	Klemmset CU vn F1-18-2 18x1mm / 2-fach Eurokonus	
88001301	Klemmset Kstrohr F3-12-2 12x2mm / 2-fach Eurokonus	
88001304	Klemmset Kstrohr F3-14-2 14x2mm / 2-fach Eurokonus	
88001305	Klemmset Kstrohr F3-16-2 16x2mm / 2-fach Eurokonus	
88001307	Klemmset Kstrohr F3-17-2 17x2mm / 2-fach Eurokonus	
88001308	Klemmset Kstrohr A3-18-2 18x2mm / 2-fach Eurokonus	
88001310	Klemmset Kstrohr F3-20-2 20x2mm / 2-fach Eurokonus	



13010110	HK Ausgleichsadapter 1/2", zum Ausgleich unterschiedlicher Nabenabstände, 35-70mm	
85780021	Rosswainer Ausgleichstülle 1/2 R 173 vc Längenausgleich 34-50 mm	
85780022	Rosswainer Ausgleichstülle 3/4 R 173 vc Längenausgleich 36-54 mm	
85780023	Rosswainer Ausgleichstülle 1 R 173 vc Längenausgleich 42-63 mm	
87000020	HK Verschraubungstülle gerade 1/2" vern.	
87000030	HK Verschraubungsüberwurfmutter für 1/2" Ventil	
84886100	HK Verlängerungstülle 1/2" x 76	
84886200	HK Verlängerungstülle 3/4" x 70	



13004150	HK Ausgleichsadapter 3/4", zum Ausgleich unterschiedl.Rohranschlüsse, Radius 15mm	
----------	---	---

76547000	HK-Blindstopfen 3/8	
76547100	HK-Blindstopfen 1/2	

76563520	HK Radiatornippel 1 1/4	
76563525	Dichtung für Radiatornippel 1 1/4, IT-300	
76563500	HK-Red-Stopfen 1 1/4x1/2 LG	
76563510	HK-Red-Stopfen 1 1/4x1/2 RG	
76563400	Entlüftungsstopfen Rad 1 1/4 LG REL32	
76563410	Entlüftungsstopfen Rad 1 1/4 RG RER32	

76547110	HK-Entlüftungsstopfen 1/2 RDT/K15	
76560000	HK-Luftschraube 1/8 vern LS 6	
76560020	HK-Luftschraube 1/4 vern LS 8	
76560030	HK-Luftschraube 3/8 vern LS 10	

76566000	HK-Schlüssel SS/RDT	
76566001	HK-Schlüssel mit Behälter	

88010387	Kupplungswinkel 3/4" Eurokonus	
88010368	ÜG- Winkel 1/2" AG x 3/4" Eurokonisch	
88001390	ÜG-Nippel 1/2"X 3/4" Euro-konisch ANS	
88010393	Kupplungsnippel 3/4" Eurokonus vern. für Anschluß mit Klemmverschraubungen	

75975012	Flamco Klemmrosette RKW 12	
75975015	Flamco Klemmrosette RKW 15	
75975018	Flamco Klemmrosette RKW 18	
75975022	Flamco Klemmrosette RKW 22	
75975028	Flamco Klemmrosette RKW 28	
75975035	Kunststoffrosette weiß 35mm innen	
75975042	Kunststoffrosette weiß 42mm innen	
75975048	Kunststoffrosette weiß 48mm innen	
75975060	Kunststoffrosette weiß 60mm innen	
75975016	Kunststoff Scharnierrosette 16mm	
30022215	HK Doppelrosette zweischalig variabel weiß Kst. / für Rohre 15mm / flach	
30022216	HK Doppelrosette zweischalig variabel weiß Kst. / für Rohre 16mm / flach	
88004203	HK Doppelrosette zweischalig 50mm flach weiß Kst. / für Rohre 10-22 mm	

Fußbodenheizung

Artikelnummer Bezeichnung

Abbildung

70050590 FB-Heizung Wecoflex Integralmatte spezial
IML-S Rolle Breite 1,25m Länge 60m = 75qm



70060140 FB-Heizung Randdämmstreifen PE-F, 150x8 mm
25m Rolle / mit Folienschürze / selbstkle.



70007140 FB-Heizung Noppenplatte ohne Dämmung
1400x800mm = 1,12 m²

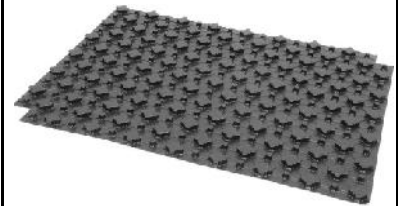

70009731 FB-Heizung TAC Systemrolldämmung 30-3
1m x 10 m / VPE 10 m²



79701200 Ankerclips für FB-Heizung, Kst schwarz AC17
1000 Stück



<p>70003699 FB Heizungsrohr 17x2 mm / 200mRolle PE-RT DD</p>	
<p>70003765 FB Heizungsrohr 17x2 mm / 600mRolle PE-RT DD</p>	

<p>70080050 FB-Heizung Noppenplatte mini ohne Dämmung für Rohr 12mm VPE 10qm</p>	
<p>70111231 FB-Heizungsrohr 12x1,5mm 120m Rolle PE-RT 5-Schicht-Rohr diffusionsdicht</p>	





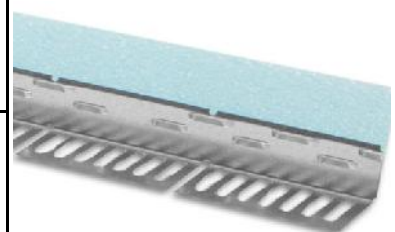
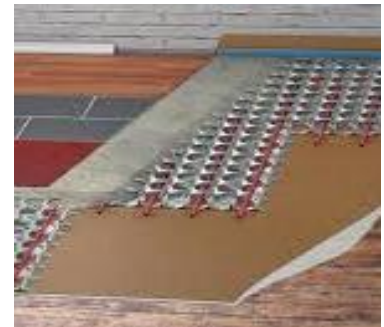
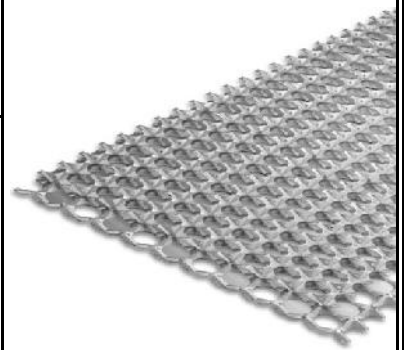













70000010	effidur Wabenplatte, Systemhöhe 10mm, offen verzinkt, 1 Platte = 0,5 m ² (1192mm x 556 mm)
70000020	effidur Wabenplatte, Systemhöhe 20mm offen verzinkt, 1 Platte = 0,5 m ² (1192mm x 556mm)
70102011	effidur Schrenzlage, folienbesch. Kraftpapier zur Abdeck.d. Trennschicht; 1,1m ² /m ² B=1,30m
70100010	effidur Randdämmstreifen für WP 1000 verzinkt, Länge 1000 mm (ca.1,3m / m ²)
70100020	effidur Randdämmstreifen für WP 2000 verzinkt, Länge: 1000 mm ca.1,3m / m ²
79102010	effidur Halteklammer für WP1000 und WP2000 verzinkt, Länge: 102 mm; 3 Stck / m







70900270	effidur 5-Schicht-Verbundrohr D 8x1,1mm Bundlänge 200m, max.95°C, ca.8,5m / m ²
70900670	effidur 5-Schicht-Verbundrohr D 8x1,1 mm Bundlänge 600 m, max. 95°C,ca. 8,5m / m ²
79591906	effidur Rohrschutzkappe D 8mm zum Verschließen d.Rohrenden
79686004	effidur Bauschutz - Wellrohr L=200mm mechan. Schutz der Heizrohre
79980820	effidur Einzel-Steckanschluss D8mm-1/2" IG inkl. 1 Kupferstützhülse D 8x1 mm
79980821	effidur Einzel-Steckanschluss D8mm-1/2" AG inkl. 1x Kupferstützhülse D 8x1 mm
79933520	effidur Unterverteiler 2-fach Steckanschl D 8mm-1/2" IG,inkl.2xKupferstützh.D8x1mm
79980823	effidur Anschlussverschraubung 3/4" Eurokonus ÜM x 1/2" AG









79933620	effidur Unterverteiler 4-fach Steckanschl. D 8mm-1/2"IG inkl.4xKupferstützhülse D8x1mm	
70904820	effidur Verteilerbaugruppe 4-fach mit Vor- und Rücklaufbalken Länge: 165 mm	
70904821	effidur Verteilerbaugruppe 6-fach mit Vor- und Rücklaufbalken Länge: 215 mm	
79186003	effidur Kupferstützhülse D 8x1mm zur Kalibr.+Aussteifung d.Heizrohrenden	
79794610	effidur Verschlussstopfen D 8mm, Länge=26mm zum Verschließen v. Verteileranschlüssen	
79980822	effidur Reparaturkupplung, 8mm für die Reparatur von Rohrbeschädigungen	
70102012	effidur Systemfließmörtel 25 kg/ Sack zum Vergießen der Wabenplatten	



70180018	Klimaboden Gipsfaser-Längsplatte m. Umlenkung 1000 x 620 x 18 mm für 12mm Rohr	
70180019	Klimaboden Gipsfaser - Umlenkplatte 310 x 620 x 18 mm für 12mm Rohr	
70180020	Klimaboden Gipsfaser - Ausgleichsplatte ungefräst 1000 x 1500 x 18 mm	
70091212	FB-Heizungsrohr 12x1,3mm 200m Rolle Polybuten DD	
70180101	Klimaboden Schnellschrauben 3,9x30mm Paket=1000 Stck	
70180200	Klimaboden Estrichkleber Flasche a 1Liter	
70180201	Klimaboden Flexkleber Sack 25kg zur Fixierung der verschied. Systemplatten	
70180202	Klimaboden Fugenspachtel Sack a 5kg höchste Festigkeit ca 0,2kg pro m²	
70170016	Klimaboden Klemmverschraubung z. Anschluss d. Rohres 12x1,3mm an Systemverteiler	
70170017	Klimaboden Verbindungskupplung für Rohr 12x1,3mm VPE 10Stck	

84161882	RTL-Ventilset 1/2 D best. aus Kopf u.Ventil	
84161883	RTL-Ventilset 1/2 E best.aus Kopf u.Ventil	
84161887	Regelbox RTL-ER für rücklauftemp.abhängige Regelung von FB-Heizungen	
84161889	Kombibox, Raum-und Rücklaufabhängige Regelung, inkl. RTL- und TH-Kopf	
84810026	UP-RTL Regelbox für kombinierte Regelung von Heizkörper- u.Fußbodenanschluss	

84469101	Regeleinheit f.FußBodenHeizung. m.UWÄ-Pumpe mit Vorlauffühler 20-50°C +Temperaturbegr.	
84413213	Regelmodul Pumpenlogik mit Überlastungsschutz	
84413210	Klemmleiste 230V für Stellantriebe FBH Verdrahtungszentrum, potentialfrei	
84469760	Elektroth. Stellantrieb 230V M30 stromlos geschlossen	
84460811	Elektroth. Stellantrieb 230V HERZ universal stromlos geschlossen	
84460820	Elektroth. Stellantrieb 230V HERZ universal stromlos offen	
84460880	Adapterring für Herz für HERZ Stellantrieb	
84460890	Adapterring für Herz und Polytherm für Herz Stellantrieb universal / M28	
84460891	Adapterring für Honeywell und Oreg für HERZ Stellantrieb universal	
84460893	Adapterring für Giacomini für HERZ Stellantrieb	
84460898	Adapterring für Heimeier für HERZ M30 Stellantrieb	

84463759	Elektroth. Stellantrieb 230V M30 stromlos offen Sonderbeschaffung	
84469769	Elektroth. Stellantrieb 24V M28 stromlos geschlossen	
84469763	Elektr. Raumthermostat 230V f. FBHzg. analog	
18021111	Digitales Raumthermostat 230V mit Temperaturanzeige	
70381021	Siemens Raumtemperaturregler REV 24 mit Wochenprogramm und digitaler Schaltuhr	

70025000	Verteileranschluss-Set 1" IG/AG waagrecht für HK Verteiler / Kugelhahn Vor-u.Rücklauf	
70025102	HK Verteiler,2fach,1"IGx3/4"Eurok, KFE Hahn Durchflußreguliertventil,,Halterung	
70025103	HK Verteiler,3fach,1"IGx3/4"Eurok, KFE Hahn Durchflußreguliertventil,Halterung	
70025104	HK Verteiler.4fach,1"IGx3/4"Eurok.,KFE Hahn Durchflußreguliertventil,Halterung	
70025105	HK Verteiler,5fach,1"IGx3/4"Eurok.,KFE Hahn Durchflußreguliertventil,Halterung	
70025106	HK Verteiler,6fach,1"IGx3/4"Eurok.,KFE Hahn Durchflußreguliertventil,Halterung	
70025107	HK Verteiler,7fach,1"IGx3/4"Eurok.,KFE Hahn Durchflußreguliertventil,Halterung	
70025108	HK Verteiler,8fach,1"IGx3/4"Eurok.,KFE Hahn Durchflußreguliertventil,Halterung	
70025109	HK Verteiler,9fach,1"IGx3/4"Eurok.,KFE Hahn Durchflußreguliertventil,Halterung	
70025110	HK Verteiler,10fach,1"IGx3/4"Eurok,KFE Hahn Durchflußreguliertventil,Halterung	
70025111	HK Verteiler,11fach,1"IGx3/4"Eurok,KFE Hahn Durchflußreguliertventil,Halterung	
70025112	HK Verteiler,12fach,1"IGx3/4"Eurok,KFE Hahn Durchflußreguliertventil,Halterung	

75220004	Verteilerschrank VSU-1 445 2-3HK	
75220006	Verteilerschrank VSU-2 545 4-5HK	
75220008	Verteilerschrank VSU-3 695 6-8HK	
75220010	Verteilerschrank VSU-4 845 9-10HK	
75220012	Verteilerschrank VSU-5 1045 11-12HK	
75224004	Verteilerschrank VSA-1 400 2-3HK	
75224005	Verteilerschrank VSA-2 600 4-5HK	
75224006	Verteilerschrank VSA-3 750 6-8HK	
75224007	Verteilerschrank VSA-4 900 9-10HK	
75224008	Verteilerschrank VSA-5 1100 11-12HK	
75224009	Verteilerschrank VSA-6 1200 13-15HK	

Standardkeramik

Artikelnummer Bezeichnung

Abbildung

79097064	HERZ Sockelleiste 40x88 Weiß Länge 4m	
79091014	HERZ Sockelleiste 40x88 Eiche hell Länge 4m	
79097044	HERZ Sockelleiste 40x88 Buche Länge 4m	

79094000	HERZ Rohrhalter schiebbar bis 22mm für Sockelleisten	
----------	---	---

79091210	HERZ Stoßverbinder Eiche hell für Sockelleiste	
79091830	HERZ Stoßverbinder Buche für Sockelleiste	
79091931	HERZ Stoßverbinder Weiß für Sockelleiste	

79091991	HERZ Innenecke Weiß steckbar keine Gehrungsschnitte notwendig	
79095850	HERZ Innenecke Eiche hell steckbar keine Gehrungsschnitte notwendig	
79091890	HERZ Innenecke Buche steckbar keine Gehrungsschnitte notwendig	

79091981	HERZ Außenecke Weiß steckbar keine Gehrungsschnitte notwendig	
79095810	HERZ Außenecke Eiche hell steckbar keine Gehrungsschnitte notwendig	
79091880	HERZ Außenecke Buche steckbar keine Gehrungsschnitte notwendig	

79091290	HERZ Innenecke Eiche hell klein zur Abdeckung der Gehrungsschnitte	
79091850	HERZ Innenecke Buche klein zur Abdeckung der Gehrungsschnitte	

79091250	HERZ Außenecke Eiche hell klein zur Abdeckung der Gehrungsschnitte	
79091840	HERZ Außenecke Buche klein zur Abdeckung der Gehrungsschnitte	

79091961	HERZ Enddeckel rechts weiß für Sockelleiste	
79091330	HERZ Enddeckel rechts Eiche hell für Sockelleiste	
79091860	HERZ Enddeckel rechts Buche für Sockelleiste	

79091971	HERZ Enddeckel links Weiß für Sockelleiste	
79091370	HERZ Enddeckel links Eiche hell für Sockelleiste	
79091870	HERZ Enddeckel links Buche für Sockelleiste	